



PRODUCT CATALOG



CONTENTS

Eberhardt	2 - 3
Ferguson	4
Fortschritt	5
Gassner	6 - 8
Gregoire Besson	9 - 11
Heger	12 - 15
Holmer - Rope	16
Horsch	17
IMT	18
KMF	19
Kongskilde	20 - 21
Krone	22 - 24
Kuhn	25 - 28
Kverneland	29 - 33
Landsberg - Pöttinger	34 - 40
Lemken	41 - 46
Överum	47 - 52
Rabe-Werk	53 - 56
Regent	57 - 66
Ross (PHX, Agrozet)	67
Sanderum (Fraudge)	68 - 69
Simba	70
Väderstadt	71 - 73
Vogel & Noot	74 - 83

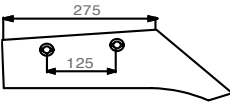
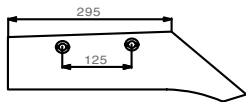
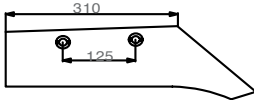
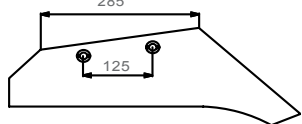
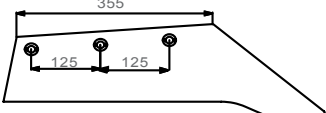
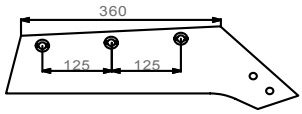
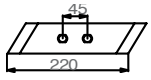
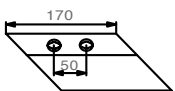
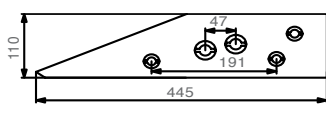
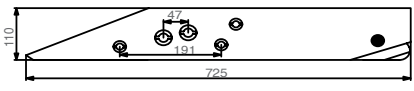
Image	No.	Original no.	Name
	0100	A384 S, A372 S	Beak shares: Right
	0101	A384 SL, A372 SL	Beak shares: Left
	0102	A 404 S	Beak shares: Right
	0103	A 404 S	Beak shares: Left
	0104	A 436 S	Beak shares: Right
	0105	A 436 S	Beak shares: Left
	0106	S 53224, 53154 S53210, S53220	
	0107	S 53225, 53155 S53211, S53221	Beak shares: Left
	0108	S 54554, S 54564 S 54560	
	0109	S 54555, S 54565 S 54561	Beak shares: Left
	0110	1000	Shares for rev. point: Right
	0111	1010	Shares for rev. point: Left
	0112	1000	Reversible points: Right
	0113	1010	Reversible points: Left
	0114	S 22 602	Skim point: Right
	0115	S 22 603	Skim point: Left
	0116	AN 110210	Short landsides: Right
	0117	AN 110211	Short landsides: Left
	0118	AN 110222	Long landsides: Right
	0119	AN 110223	Long landsides: Left

NOTE:

- All parts are made of B27 steel. It is possible to use other materials according to specific request.
- All parts are heat treated.
- Painting with water based eco-friendly colors, or powder coated upon request.
- Possibility of welded hardened/self-sharpening blades upon request.

Image	No.	Original no.	Name
	0120	301 162	Landsides: Right and: Left
	0121	301 224	Landsides tips: Right
	0122	301 223	Landsides tips: Left
	0123	306 006	Landside protections
	0124	40000	Shin places: Right
	0125	40001	Shin places: Left
	0126	40002	Shin places: Right
	0127	40003	Shin places: Left
	0128	301 668	Shin places: Right
	0129	301 669	Shin places: Left
	0130	301 160	Shin places: Right
	0131	301 161	Shin places: Left

NOTE:

- All parts are made of B27 steel. It is possible to use other materials according to specific request.
- All parts are heat treated.
- Painting with water based eco-friendly colors, or powder coated upon request.
- Possibility of welded hardened/self-sharpening blades upon request.

Image	No.	Original no.	Name
	0160	394 0330	Pointed shares: for 12" / 14": Right
	0161	394 0034	Pointed shares: for 12" / 14": Left
	0162	394 0328	Pointed shares tips: Right
	0163	394 0337	Pointed shares tips: Left
	0164	394 0306	Skin places: Right
	0165	394 0315	Skin places: Left

NOTE:

- All parts are made of B27 steel. It is possible to use other materials according to specific request.
- All parts are heat treated.
- Painting with water based eco-friendly colors, or powder coated upon request.
- Possibility of welded hardened/self-sharpening blades upon request.

Image	No.	Original no.	Name
	0190	301000045	Pointed shares: Right B 200, B 201
	0191	301000045 WS	Shares for reversible point: Right
	0192	93105	Reversible point: Right
	0193	301010171	Short landsides: Right
	0194	301010158	Long landsides: Right
	0195	301010160	Short landsides: Right
	0196	301010172	Long landsides: Right
	0197	63601A	Landside protections
	0198	636001	Landside protections
	0199	73091	Share knife

NOTE:

- All parts are made of B27 steel. It is possible to use other materials according to specific request.
- All parts are heat treated.
- Painting with water based eco-friendly colors, or powder coated upon request.
- Possibility of welded hardened/self-sharpening blades upon request.

Image	No.	Original no.	Name
	0220	SS 1080	Beak shares: Right
	0221	SS 1090	Beak shares: Left
	0222	SS 1040	Beak shares: Right
	0223	SS 1050	Beak shares: Left
	0224	SS 1140	Beak shares: Right
	0225	SS 1150	Beak shares: Left
	0226	SS 1100	Beak shares: Right
	0227	SS 1110	Beak shares: Left
	0228	SS 1060	Beak shares: Right
	0229	SS 1070	Beak shares: Left
	0230	SS 1120	Beak shares: Right
	0231	SS 1130	Beak shares: Left
	0232	SS 1180	Beak shares: Right
	0233	SS 1190	Beak shares: Left
	0234	SS 1160	Beak shares: Right
	0235	SS 1170	Beak shares: Left
	0236	SS 1240	Beak shares: Right
	0237	SS 1250	Beak shares: Left
	0238	AS - 185	Reversible for beak shares: Right
	0239	AS - 185	Reversible for beak shares: Left







NOTE:

- All parts are made of B27 steel. It is possible to use other materials according to specific request.
- All parts are heat treated.
- Painting with water based eco-friendly colors, or powder coated upon request.
- Possibility of welded hardened/self-sharpening blades upon request.

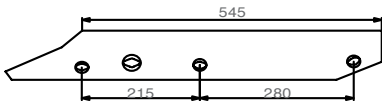
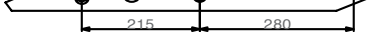
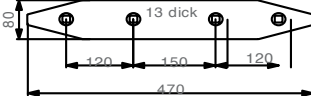
Image	No.	Original no.	Name
	0240	MSS 11382	Shares for rev. points: Right
	0241	MSS 11383	Shares for rev. points: Left
	0242	MSS 11384	Shares for rev. points: Right
	0243	MSS 11385	Shares for rev. points: Left
	0244	MSS 1560	Shares for rev. points: Right
	0245	MSS 1570	Shares for rev. points: Left
	0246	MRSS 1580	Shares for rev. points: Right
	0247	MRSS 1590	Shares for rev. points: Left
	0248	FR 2, D 12 R	Skim points: Right
	0249	FR 2, D 12 L	Skim points: Left
	0250	FR 3	Skim points: Right
	0251	FR 3	Skim points: Left
	0252	11834	Skim points: Right
	0253	11835	Skim points: Left
	0254	K 1073	Short landsides: Right
	0255	K 1083	Short landsides: Right
	0256	K 1090	Short landsides: Left
	0257	L 1063	Long landsides: Right
	0258	L 1073	Long landsides: Left

NOTE:

- All parts are made of B27 steel. It is possible to use other materials according to specific request.
- All parts are heat treated.
- Painting with water based eco-friendly colors, or powder coated upon request.
- Possibility of welded hardened/self-sharpening blades upon request.

Image	No.	Original no.	Name
	0259	L 1083	Long landsides: Right
	0260	L 1093	Long landsides: Left
	0261	L 1582	Long landsides
	0262	VST 1080	Shin pieces: Right
	0263	VST 1090	Shin pieces: Left
	0264	VST 1120	Shin pieces: Right
	0265	VST 1130	Shin pieces: Left
	0266	VST 1160	Shin pieces: Right
	0267	VST 1170	Shin pieces: Left

NOTE:

- All parts are made of B27 steel. It is possible to use other materials according to specific request.
- All parts are heat treated.
- Painting with water based eco-friendly colors, or powder coated upon request.
- Possibility of welded hardened/self-sharpening blades upon request.

Parts for:

GREGOIRE BESSON



Image	No.	Original no.	Name
	0290	173 324	Sword coulters: Right
	0291	173 323	Sword coulters: Left
	0292	19 188	Blade of the skimmer: Right
	0293	19 187	Blade of the skimmer: Left
	0294	19 179	Rack
	0295	178 114	Shin pieces: Right
	0296	178 113	Shin pieces: Left
	0297	177 349	Landside protections
	0298	173 476	Shin pieces: Right
	0299	173 475	Shin pieces: Left
	0300	178 112	Slats: Right
	0301	178 111	Slats: Left
	0302	178 108	Slats: Right
	0303	178 107	Slats: Left
	0304	178 110	Slats: Right
	0305	178 109	Slats: Left

NOTE:

- All parts are made of B27 steel. It is possible to use other materials according to specific request.
- All parts are heat treated.
- Painting with water based eco-friendly colors, or powder coated upon request.
- Possibility of welded hardened/self-sharpening blades upon request.

Image	No.	Original no.	Name
	0306	178 112	Slats: Right
	0307	178 111	Slats: Left
	0308	173424	Shares for rev. points 14": Right
	0309	173423	Shares for rev. points 14": Left
	0310	173332	Reversible points: Right
	0311	173331	Reversible points: Left
	0312	173614	Shares for. rev. points: Right
	0313	173613	Shares for. rev. points: Left
	0314	19114	Skim points: Right
	0315	19113	Skim points: Left
	0316	177312	Landsides: Right and: Left
	0317	177MOL	Landsides: Right and: Left
	0318	173338	Short landsides: Right
	0319	173337	Short landsides: Left
	0320	173388	Landsides
	0321	636300	Landsides protections: Right and Left

NOTE:

- All parts are made of B27 steel. It is possible to use other materials according to specific request.
- All parts are heat treated.
- Painting with water based eco-friendly colors, or powder coated upon request.
- Possibility of welded hardened/self-sharpening blades upon request.

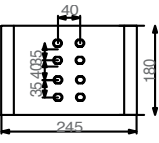
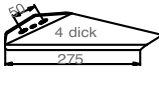
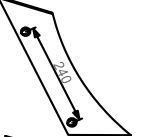
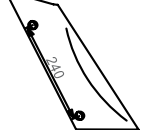
Image	No.	Original no.	Name
	0322	63601A	Landsides protections: Right and Left
	0323 0324	173 MOL R 173 MOL L	Share knife Share knife
	0325 0326	173404 173403	Shin pieces: Right Shin pieces: Left
	0327 0328	173322 173321	Shin pieces: Right Shin pieces: Left

NOTE:

- All parts are made of B27 steel. It is possible to use other materials according to specific request.
- All parts are heat treated.
- Painting with water based eco-friendly colors, or powder coated upon request.
- Possibility of welded hardened/self-sharpening blades upon request.

Image	No.	Original no.	Name
	0340	5 HE	Pointed shares: Right
	0341	5 HE	Pointed shares: Left
	0342	HK 1	Pointed shares
	0343	K 1S	Beak shares
	0344	HK 2 S S	Pointed shares
	0345	7 HY	Pointed shares
	0346	8 HY	Pointed shares: Right
	0347	8 HY	Pointed shares: Left
	0348	9 HY	Pointed shares: Right
	0349	9 HY	Pointed shares: Left
	0350	11 HY	Pointed shares: Right
	0351	11 HY	Pointed shares: Left
	0352	8 HY S	Beak shares: Right
	0353	8 HY S	Beak shares: Left
	0354	9 HY S	Beak shares: Right
	0355	9 HY S	Beak shares: Left

NOTE:

- All parts are made of B27 steel. It is possible to use other materials according to specific request.
- All parts are heat treated.
- Painting with water based eco-friendly colors, or powder coated upon request.
- Possibility of welded hardened/self-sharpening blades upon request.

Image	No.	Original no.	Name
	0356	9 HY W	Shares for revisible point: Right
	0357	9 HY W	Shares for revisible point: Left
	0358		Reversible points: Right
	0359		Reversible points: Left
	0360		Skim points: Right
	0361		Skim points: Left
	0362	HK 1	Long landsides
	0363	HK 1	Short landsides
	0364	HK 2 N	Long landsides
	0365	HK 2 N	Short landsides
	0366	7 HE	Long landsides
	0367	7 HE	Short landsides
	0368	7 HL	Short landsides





NOTE:

- All parts are made of B27 steel. It is possible to use other materials according to specific request.
- All parts are heat treated.
- Painting with water based eco-friendly colors, or powder coated upon request.
- Possibility of welded hardened/self-sharpening blades upon request.

Image	No.	Original no.	Name
	0369	8 HE	Long landsides
	0370	8 HE	Short landsides
	0371	8 HY	Short landsides
	0372	8 HM	Long landsides: Right
	0373	8 HM	Long landsides: Left
	0374	8 HM	Short landsides: Right
	0375	8 HM	Short landsides: Left
	0376	10 HM	Short landsides: Right
	0377	10 HM	Short landsides: Left
	0378	11 HM	Long landsides: Right and: Left
	0379	9 HR, 14 HR 54 292 502	Landside protections
	0380	8 HM - AK	Shin pieces: Right
	0381	8 HR - AK	Shin pieces: Right

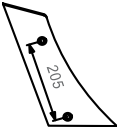
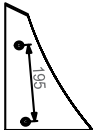
NOTE:

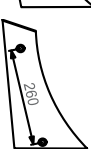
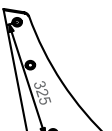
- All parts are made of B27 steel. It is possible to use other materials according to specific request.
- All parts are heat treated.
- Painting with water based eco-friendly colors, or powder coated upon request.
- Possibility of welded hardened/self-sharpening blades upon request.

Image	No.	Original no.	Name
	0382	8 HY - AK	Shin pieces: Right
	0383	9 HM - AK	Shin pieces: Right
	0384	9 HR - AK, 14 HR 56 258 505	Shin pieces: Right
	0385	9 HR - AK, 14 HR 56 259 504	Shin pieces: Left
	0386 0387	11 HM - AK 11 HM - AK	Shin pieces: Right Shin pieces: Left
	0388	12 HM - AK	Shin pieces: Right

NOTE:

- All parts are made of B27 steel. It is possible to use other materials according to specific request.
- All parts are heat treated.
- Painting with water based eco-friendly colors, or powder coated upon request.
- Possibility of welded hardened/self-sharpening blades upon request.

Image	No.	Original no.	Name	
	0410	180IND-83	Flail	
	0411	18034-HOL-02	Head blade	
	0412	KBRB400	Tropper knife	
	0413	18034-802R	Beet harvester share: Right	
	0414	18034-802L	Beet harvester share: Left	
	0415	ROPA 206078	Hammer: Right	
	0416	ROPA 206079	Hammer: Left	
	0417	Holmer T4 - R	Beet harvester share: Right	
	0418	Holmer T4 - L	Beet harvester share: Left	

NOTE:

- All parts are made of B27 steel. It is possible to use other materials according to specific request.
- All parts are heat treated.
- Painting with water based eco-friendly colors, or powder coated upon request.
- Possibility of welded hardened/self-sharpening blades upon request.

Image	No.	Original no.	Name
	0440	60 012 665	Protractor: Right
	0441	60 012 677	Protractor: Left
	0442	34 060 859	Guide plate: Right
	0443	34 060 858	Guide plate: Left
	0444	34 060 850	Chisel point
	0445	311 329	Wing share: Right
	0446	311 329	Wing share: Left
	0447	311 327	Short wing share: Right
	0448	311 326	Short wing share: Left
	0449	60 034 719	Hoe row cultivator
	0450	311 575	Hoe row cultivator

NOTE:

- All parts are made of B27 steel. It is possible to use other materials according to specific request.
- All parts are heat treated.
- Painting with water based eco-friendly colors, or powder coated upon request.
- Possibility of welded hardened/self-sharpening blades upon request.

Image	No.	Original no.	Name
	0470		Back landsides
	0471		Front landsides
	0472		Back landsides
	0473		Front landsides
	0474		Shin pieces
	0475		Shin pieces
	0476		Beak shares
	0477		Beak shares

NOTE:

- All parts are made of B27 steel. It is possible to use other materials according to specific request.
- All parts are heat treated.
- Painting with water based eco-friendly colors, or powder coated upon request.
- Possibility of welded hardened/self-sharpening blades upon request.

Image	No.	Original no.	Name
	0500	CV 00061, 257 C	Beak shares: Right
	0501	CV 00062, 257 C	Beak shares: Left
	0502	WY 25, 256 C P 93.001.01	Beak shares: Right
	0503	WY 25, 256 C P 93.002.01	Beak shares: Left
	0504	274, P66.070.01	Skim points: Right
	0505	274, P66.070.04	Skim points: Left
	0506	274, 274.00.18 P 82.074.01	Front landsides: Right
	0507	274, 274.00.17 P 82.075.01	Front landsides: Left
	0508	274, 274.00.10 P 82.076.00	Back landsides: Right
	0509	274, 274.00.11 P 82.077.00	Back landsides: Left
	0510	286 P 82.076.02	Landside protections: Right and Left

NOTE:

- All parts are made of B27 steel. It is possible to use other materials according to specific request.
- All parts are heat treated.
- Painting with water based eco-friendly colors, or powder coated upon request.
- Possibility of welded hardened/self-sharpening blades upon request.

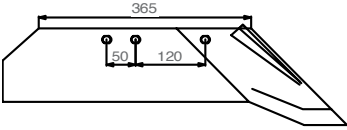
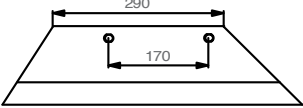
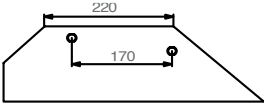
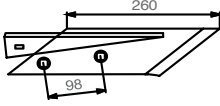
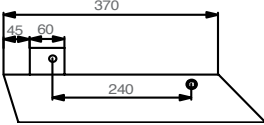
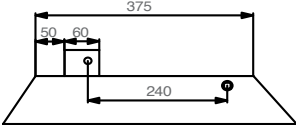
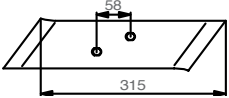
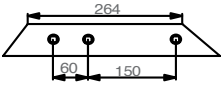
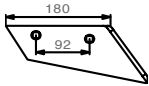
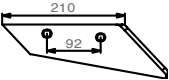
Image	No.	Original no.	Name
	0530	T 62-12W 900 60 001	Beak shares 12"-14": Right
	0531	T 62-12W 900 60 051	Beak shares 12"-14": Left
	0532	T 88	Share points 16": Right
	0533	T 88	Share points 16": Left
	0534	T 77 900 60 005	Share points 14": Right
	0535	T 77 900 60 055	Share points 14": Left
	0536	T 77 900 62 090	Share points 14": Right
	0537	T 83 900 62 103	Lower shares 14": Right
	0538	T 83 900 62 107	Lower shares 14": Left
	0539	T 83 900 62 106	Lower shares 16": Right
	0540	T 83 900 62 108	Lower shares 16": Left
	0541	T 83 / T 88/21 900 60 185	Reversible point: Right
	0542	T 83 / T 88/21 900 60 189	Reversible point: Left
	0543	T 83 900 60 184	Upper shares: Right
	0544	T 83 900 60 188	Upper shares: Left
	0545	PF 16-6 900 60 100	Skim point: Right
	0546	PF 16-19 900 60 110	Skim points: Left

NOTE:

- All parts are made of B27 steel. It is possible to use other materials according to specific request.
- All parts are heat treated.
- Painting with water based eco-friendly colors, or powder coated upon request.
- Possibility of welded hardened/self-sharpening blades upon request.

Image	No.	Original no.	Name
	0547	T 53	Short landsides
	0548	T 53L	Long landsides
	0549	T153 E 900 63 100	Short landsides: Right
	0550	T153 E	Short landsides: Left
	0551	T153E 900 63 101	Long landsides: Right
	0552	T153E	Long landsides: Left
	0553	T 88/21 90 230 020	Landsides
	0554	PF 8 - 42 90 060 293	Landside protections
	0555	T 53 MK	Shin pieces
	0556	T153E 900 60 301	Shin pieces 12" - 14": Right
	0557	T 88 / 21 90 210 079	Shin pieces: Right
	0558	T 88 / 21 90 210 078	Shin pieces: Left

NOTE:

- All parts are made of B27 steel. It is possible to use other materials according to specific request.
- All parts are heat treated.
- Painting with water based eco-friendly colors, or powder coated upon request.
- Possibility of welded hardened/self-sharpening blades upon request.

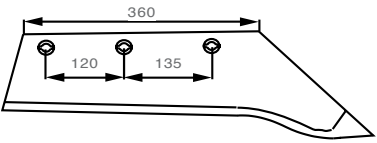
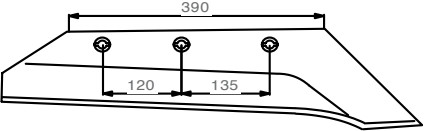
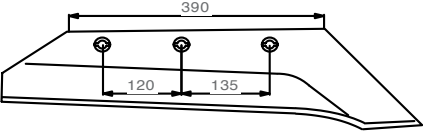
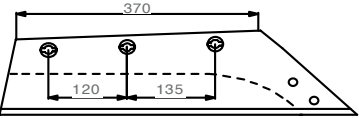
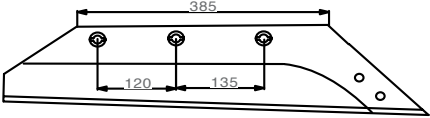
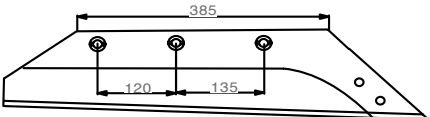
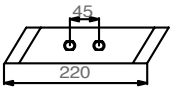
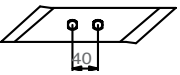
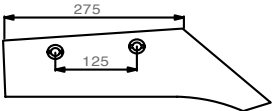
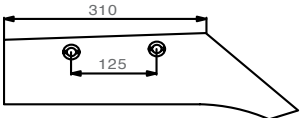
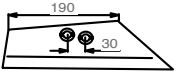
Image	No.	Original no.	Name
	0580	969.007.0	Beak shares: Right
		969.005	
	0581	969.107.0	Beak shares: Left
		969.105	
	0582	969.009.0	Beak shares: Right
	0583	969.109.	Beak shares: Left
	0584	969.021.0	Shares for rev. points: Right
	0585	969.121.0	Shares for rev. points: Left
	0586	969.029.0	Shares for rev. points: Right
	0587	969.129.0	Shares for rev. points: Left
	0588	968.803.0	Shares for rev. points: Right
	0589	968.903.0	Shares for rev. points: Left
	0590	929.099.0	Reversible points: Right
	0591	929.199.0	Reversible points: Left
	0592	969.098.0	Reversible points: Right
	0593	969.198.0	Reversible points: Left
	0594	U8R 929.042.0	Beak shares: Right
	0595	U8L 929.142.0	Beak shares: Left
	0596	U10R 929.044.0	Beak shares: Right
	0597	U10L 929.144.0	Beak shares: Left
	0598	969.092.1	Skim points: Right
		969.192.1	Skim points: Left

NOTE:

- All parts are made of B27 steel. It is possible to use other materials according to specific request.
- All parts are heat treated.
- Painting with water based eco-friendly colors, or powder coated upon request.
- Possibility of welded hardened/self-sharpening blades upon request.

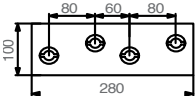
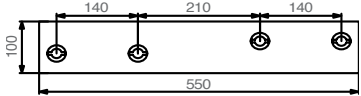
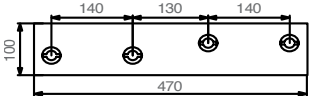
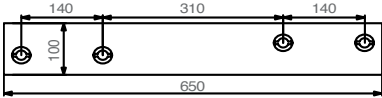
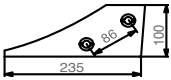
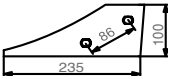
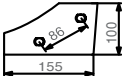
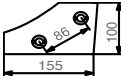
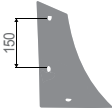
Image	No.	Original no.	Name
	0599	929.090.0 929.190.0	Skim points: Right Skim points: Left
	0600	KG 8-9-10 123.029.0	Short up-front landsides: Right
	0601	KG 8-9-10 123.159.0	Short up-front landsides: Left
	0602	KG 8-9-10 123.160.0	Long back landsides: Right
	0603	KG 8-9-10 123.161.0	Long back landsides: Left
	0604	KG 12-14-16 123.162.0	Short up-front landsides: Right
	0605	KG 12-14-16 123.163.0	Short up-front landsides: Left
	0606	KG 12-14-16 123.164.0	Back landsides short: Right
	0607	KG 12-14-16 123.165.0	Back landsides short: Left
	0608	123.165.0	Landside tips: Right
	0609	123.112.1	Landside tips: Left
	0610	123.601.2	Landside points: Right
	0611	123.602.2	Landside points: Left
	0612	123.229.1	Landside tips: Right
	0613	123.230.1	Landside tips: Left
	0614	123.229	Landside tips: Right
	0615	123.230	Landside tips: Left
	0616	959.403.0	Shin pieces: Right
	0617	959.423.0	Shin pieces: Left

NOTE:

- All parts are made of B27 steel. It is possible to use other materials according to specific request.
- All parts are heat treated.
- Painting with water based eco-friendly colors, or powder coated upon request.
- Possibility of welded hardened/self-sharpening blades upon request.

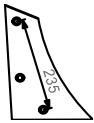
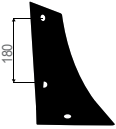
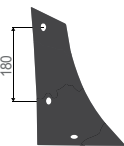
Image	No.	Original no.	Name
	0618	959 405 0	Shin pieces: Right
	0619	959 425 0	Shin pieces: Left
	0620	959 407 0	Shin pieces: Right
	0621	959 427 0	Shin pieces: Left
	0622	959 415 0	Shin pieces: Right
	0623	959 435 0	Shin pieces: Left

NOTE:

- All parts are made of B27 steel. It is possible to use other materials according to specific request.
- All parts are heat treated.
- Painting with water based eco-friendly colors, or powder coated upon request.
- Possibility of welded hardened/self-sharpening blades upon request.

Image	No.	Original no.	Name
	0650	62086 C	Beak shares 12": Right
	0651	62087 C	Beak shares 12": Left
	0652	62088 C	Beak shares 14": Right
	0653	62089 C	Beak shares 14": Left
	0654	622 134 62 218, 62 220	Shares for rev. points 14": Right
	0655	622 135 62 219, 62 221	Shares for rev. points 14": Left
	0656	622 136	Shares for rev. points 16": Right
	0657	622 137	Shares for rev. points 16": Left
	0658	622 166	Shares for rev. point: Right
	0659	622 167	Shares for rev. point: Left
	0660	622 140	Shares for rev. points 14": Right
	0661	622 141	Shares for rev. points 14": Left
	0662	622 142	Shares for rev. points 16": Right
	0663	622 143	Shares for rev. points 16": Left
	0664	622 172	Shares for rev. points 16": Right
	0665	622 173	Shares for rev. points 16": Left
	0666	622 128	Reversible points: Right
	0667	622 129	Reversible points: Left
	0668	622 180	Reversible points: Right
	0669	622 181	Reversible points: Left

NOTE:

- All parts are made of B27 steel. It is possible to use other materials according to specific request.
- All parts are heat treated.
- Painting with water based eco-friendly colors, or powder coated upon request.
- Possibility of welded hardened/self-sharpening blades upon request.

Image	No.	Original no.	Name
	0670	622 174	Reversible points: Right
	0671	622 175	Reversible points: Left
	0672	270 103	Shares knives to welding
	0673	631 016	Skim points: Right
	0674	631 017	Skim points: Left
	0675	63120, 63128, 63130	Skim points: Right
	0676	63121, 63129, 63131	Skim points: Left
	0677	631104	Skim points: Right
	0678	631105	Skim points: Left
	0679	631 102	Skim points: Right
	0680	631 103	Skim points: Left
	0681	631 100	Skim points: Right
	0682	631 101	Skim points: Left
	0683	631108	Skim points: Right
	0684	631109	Skim points: Left
	0685	278074	Short landsides: Right
	0686	278075	Short landsides: Left
	0687	278076	Long landsides: Right
	0688	278077	Long landsides: Left

NOTE:

- All parts are made of B27 steel. It is possible to use other materials according to specific request.
- All parts are heat treated.
- Painting with water based eco-friendly colors, or powder coated upon request.
- Possibility of welded hardened/self-sharpening blades upon request.

Image	No.	Original no.	Name
	0689	279 030	Long landsides: Right
	0690	279 031	Long landsides: Left
	0691	279 028	Short landsides: Right
	0692	279 029	Short landside: Left
	0693	279 114	Landsides: Right
	0694	279 115	Landsides: Left
	0695	279 130	Landsides: Right
	0696	279 131	Landsides: Left
	0697	179 138	Landside tips: Right
	0698	279 139	Landside tips: Left
	0699	279 140	Landsides
	0700	200 645	Landsides
	0701	223 122	Landsides
	0702	233 120	Landside tips: Right
	0703	233 121	Landside tips: Left
	0704	226 100	Landside protections

NOTE:

- All parts are made of B27 steel. It is possible to use other materials according to specific request.
- All parts are heat treated.
- Painting with water based eco-friendly colors, or powder coated upon request.
- Possibility of welded hardened/self-sharpening blades upon request.

Image	No.	Original no.	Name
	0705	619200	Shin pieces: Right
	0706	619201	Shin pieces: Left
	0707	61960	Shin pieces: Right
	0708	61961	Shin pieces: Left
	0709	61940	Shin pieces: Right
	0710	61941	Shin pieces: Left
	0711	619 120	Shin pieces: Right
	0712	619 121	Shin pieces: Left
	0713	619 128	Shin pieces: Right
	0714	619 129	Shin pieces: Left
	0715	619 100	Shin pieces: Right
	0716	619 101	Shin pieces: Left
	0717	619 038	Shin pieces: Right
	0718	619 039	Shin pieces: Left
	0719	617 100	Slats 1: Right
	0720	617 102	Slats 2: Right
	0721	617 104	Slats 3: Right
	0722	617 106	Slats 4: Right
	0723	617 101	Slats 1: Left
	0724	617 103	Slats 2: Left
	0725	617 105	Slats 3: Left
	0726	617 107	Slats 4: Left

NOTE:

- All parts are made of B27 steel. It is possible to use other materials according to specific request.
- All parts are heat treated.
- Painting with water based eco-friendly colors, or powder coated upon request.
- Possibility of welded hardened/self-sharpening blades upon request.

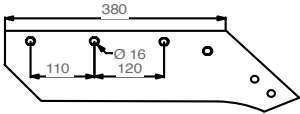
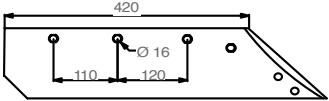
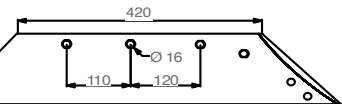
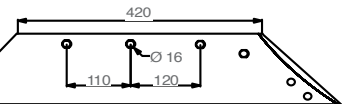
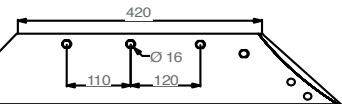
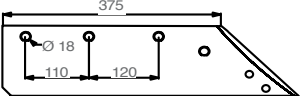
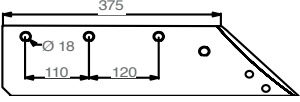
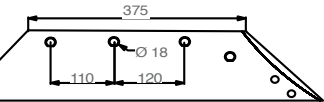
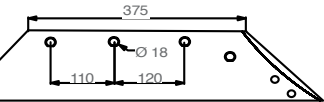
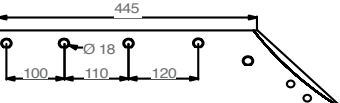
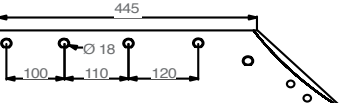
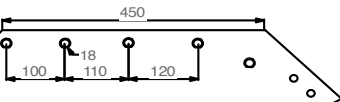
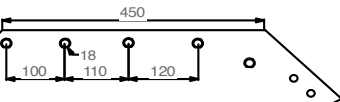
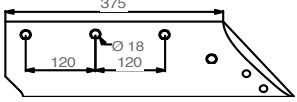
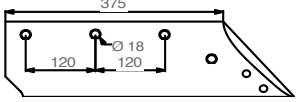
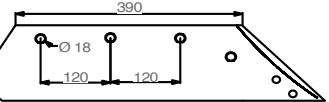
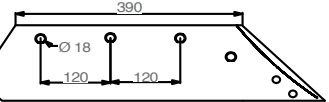
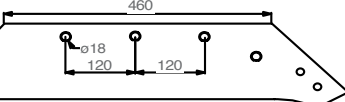
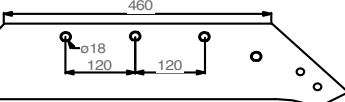
Image	No.	Original no.	Name
	0750	63 013, 63 000	Shares for rev. points 12": Right
	0751	63 014, 63 001	Shares for rev. points 12" + 14": Right
	0752	63 017, 63 007	Shares for rev. points 12" + 14": Left
	0753	63 015, 63 002	Shares for rev. points 16": Right
	0754	63 018, 63 008	Shares for rev. points 16": Left
	0755	73 002, 73 000 73 022	Shares for rev. points 12" + 14": Right
	0756	73 003, 73 023	Shares for rev. points 12" + 14": Left
	0757	73 004, 073 024	Shares for rev. points 16": Right
	0758	73 005, 072 025	Shares for rev. points 16": Left
	0759	73 006	Shares for rev. points 18": Right
	0760	73 007	Shares for rev. points 18": Left
	0761	73 008	Shares for rev. points 20": Right
	0762	73 009	Shares for rev. points 20": Left
	0763	73 054	Shares for rev. points 14": Right
	0764	73 055	Shares for rev. points 14": Left
	0765	073 056	Shares for rev. points 16": Right
	0766	073 057	Shares for rev. points 16": Left
	0767	073 080	Shares for rev. points 18": Right
	0768	073 081	Shares for rev. points 18": Left

NOTE:

- All parts are made of B27 steel. It is possible to use other materials according to specific request.
- All parts are heat treated.
- Painting with water based eco-friendly colors, or powder coated upon request.
- Possibility of welded hardened/self-sharpening blades upon request.

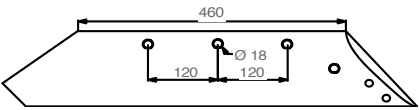
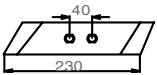
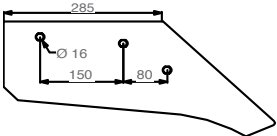
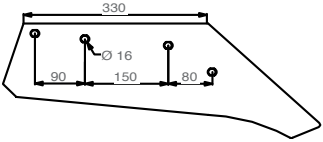
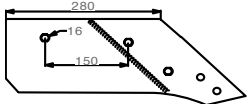
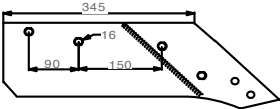
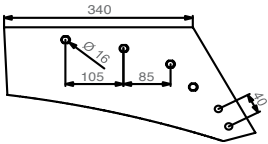
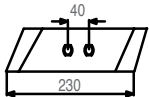
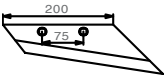
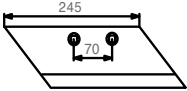
Image	No.	Original no.	Name
	0769	073 084	Shares for rev. points 20": Right
	0770	073 085	Shares for rev. points 20": Left
	0771	053 090	Reversible points: Right
	0772	063 090	Reversible points: Left
	0773	053 160 53 080	Beak shares 12": Right
	0774	053 162	Beak shares 14": Right
	0775	053 085, 053 080 053 070	Shares for rev. points 12": Right
	0776	053 087	Shares for rev. points 14": Right
	0777	053 089	Shares for rev. points 12" / 14"
	0778	053 090	Reversible points: Right
	0779	063 090	Reversible points: Left
	0780	056 888	Skim points: Right
	0781	056 852	Great skim points: Right
	0782	056 852 L	Great skim points: Left

NOTE:

- All parts are made of B27 steel. It is possible to use other materials according to specific request.
- All parts are heat treated.
- Painting with water based eco-friendly colors, or powder coated upon request.
- Possibility of welded hardened/self-sharpening blades upon request.

Image	No.	Original no.	Name
	0783	056 873	Skim points little: Right
	0784	066 873	Skim points little: Left
	0785	066 868	Skim points: Right
	0786	066 869	Skim points: Left
	0787	096 552, 2297	Skim points: Right
	0788	76 812	Skimmer mouldboards Right
	0789	76 813	Skimmer mouldboards Left
	0790	63 605, 63 615	Short front landsides: Right
	0791	63 606	Short front landsides: Left
	0792	63 603, 63 613	Long back landsides: Right
	0793	63 604	Long back landsides: Left
	0794	063 601	Long landsides: Right
	0795	063 601	Short landsides: Right
	0796	063 610	Long landsides: Right
	0797	063 611	Short landsides: Right

NOTE:

- All parts are made of B27 steel. It is possible to use other materials according to specific request.
- All parts are heat treated.
- Painting with water based eco-friendly colors, or powder coated upon request.
- Possibility of welded hardened/self-sharpening blades upon request.

Image	No.	Original no.	Name
	0798	073 608, 73 620, 73 624, 073 600, 073610	Short landsides - used for both: Right and: Left
	0799	073 609, 073 604, 073 612	Long landsides - used for both: Right and: Left
	0800	053 665, 053 661 053 667	Long landsides: Right
	0801	053 615	Short landsides: Right
	0802	053 683	Long landsides: Right
	0803	053 684	Short landsides: Right
	0804	53 681	Short landsides: Right
	0805	063 601 A	Landside protections
	0806	063 600 A	Landside protections
	0807	063 607	Intermediate plates

NOTE:

- All parts are made of B27 steel. It is possible to use other materials according to specific request.
- All parts are heat treated.
- Painting with water based eco-friendly colors, or powder coated upon request.
- Possibility of welded hardened/self-sharpening blades upon request.

Image	No.	Original no.	Name
	0808	063 608	Intermediate plates: Right
	0809	063 609	Intermediate plates: Left
	0810	073 091	Share knives: Right
	0811	073 092	Share knives: Left
	0812	134 9408	Furrow breaker: Right
	0813	134 9409	Furrow breaker: Left
	0814	063 240	Shin pieces: Right
	0815	063 250	Shin pieces: Left
	0816	073 230	Shin pieces: Right
	0817	073 231	Shin pieces: Left
	0818	73 250	Shin pieces: Right
	0819	73 251	Shin pieces: Left
	0820	73 256	Shin pieces: Right
	0821	73 257	Shin pieces: Left
	0822	7363310	Fixing parts: Right
	0823	7363311	Fixing parts: Left
	0824	053 387	Tail pieces: Right
	0825	063 388	Tail pieces: Left
	0826	73 300, 063 300	Trashboards: Right
	0827	73 301, 063 301	Trashboards: Left

NOTE:

- All parts are made of B27 steel. It is possible to use other materials according to specific request.
- All parts are heat treated.
- Painting with water based eco-friendly colors, or powder coated upon request.
- Possibility of welded hardened/self-sharpening blades upon request.

Image	No.	Original no.	Name
	0850	190.30.80 001397Z, K-032	Pointed shares 18 S: Right
	0851	190.36.00 001398Z, K-032	Pointed shares 18 S: Left
	0852	1903040, 000851Z	Beak shares
	0853	1903050, 000852Z	Beak shares
	0854	190.32.90, 001539A	Pointed shares: Right
	0855	190.35.70, 00154DA	Pointed shares: Left
	0856	925.34.000.0 1903270	Pointed shares: Right
	0857	925.35.000.0 1903280	Pointed shares: Left
	0858	1903540 001537Z, K-177	Beak shares: Right
	0859	1903390 001538Z, K-177	Beak shares: Left
	0860	190.36.14	Beak shares: Right
	0861	190.36.15	Beak shares: Left
	0862	190.39.73, 041230Z	Beak shares: Right
	0863	190.39.74, 041231Z	Beak shares: Left
	0864	925.01.000.0 1903750	Beak shares: Right
	0865	925.02.000.0 1903760	Beak shares: Left
	0866	925.03.000.0 1903020	Beak shares: Right
	0867	925.04.000.0 1903030	Beak shares: Left
	0868	925.05.000.0 190.27.40	Beak shares: Right
	0869	925.06.000.0 190.27.50	Beak shares: Left

NOTE:

- All parts are made of B27 steel. It is possible to use other materials according to specific request.
- All parts are heat treated.
- Painting with water based eco-friendly colors, or powder coated upon request.
- Possibility of welded hardened/self-sharpening blades upon request.

Image	No.	Original no.	Name
	0870	925.07.000.0 190.31.00	Beak shares: Right
	0871	925.08.000.0 190.31.10	Beak shares: Left
	0872	925.09.000.0 190.33.00	Beak shares: Right
	0873	925.10.000.0 190.33.10	Beak shares: Left
	0874	925.13.000.0 190.36.54	Beak shares: Right
	0875	925.14.000.0 190.36.55	Beak shares: Left
	0876	925.21.000.0 190.35.57	Beak shares: Right
	0877	925.22.000.0 190.35.58	Beak shares: Left
	0878	925.23.000.0 190.39.75	Beak shares: Right
	0879	925.24.000.0 190.39.76	Beak shares: Left
	0880	925.26.000.0 190.39.44	Beak shares: Right
	0881	925.27.000.0 190.39.45	Beak shares: Left
	0882	190.36.71, 041.31.7Z	Shares for rev. points: Right
	0883	190.36.72, 041.31.8Z	Shares for rev. points: Left
	0884	190.36.73, 041.319Z	Shares for rev. points: Right
	0885	190.36.74, 014.32.0Z	Shares for rev. points: Left
	0886	190.35.81, 041.32.7Z	Shares for rev. points: Right
	0887	190.35.82, 041.32.8Z	Shares for rev. points: Left
	0888	190.36.78, 041.32.9Z	Shares for rev. points: Right
	0889	190.36.79, 041.33.0Z	Shares for rev. points: Left

NOTE:

- All parts are made of B27 steel. It is possible to use other materials according to specific request.
- All parts are heat treated.
- Painting with water based eco-friendly colors, or powder coated upon request.
- Possibility of welded hardened/self-sharpening blades upon request.

Image	No.	Original no.	Name
	0890	190.36.75	Reversible points: Right
	0891	190.36.76	Reversible points: Left
	0892	925.13.115.0	Reversible cultivator points: Right
	0893	925.13.125.0	Reversible cultivator points: Left
	0894	925:13:011:0	Shares points: Right
	0895	925:13:021:0	Shares points: Left
	0896	925:26:011:0	Shares points: Right
	0897	925:26:021:0	Shares points: Left
	0898	190.36.84	Share wings: Right
	0899	940.95.022.0	Share wings: Left
	0900	190.36.86	Share wings: Right
	0901	942:95:002:0	Share wings: Left
	0902	190.36.82	Share points: Right
	0903	940:95:021:0	Share points: Left
	0904	190.36.83	Share points: Right
	0905	940:95:031:0	Share points: Left
	0906	941.95.022.0	Share wings: Right
	0907	190.39.46	Share wings: Left
	0908	941.95.032.0	Share wings: Right
	0909	190.39.47	Share wings: Left
		941.95.021.0	Share points: Right
		041.85.6Z	Share points: Right
		941.95.031.0	Share points: Left
		041.85.7Z	Share points: Left
		056461 Z	Skim points: Right
		056462 Z	Skim points: Left

NOTE:

- All parts are made of B27 steel. It is possible to use other materials according to specific request.
- All parts are heat treated.
- Painting with water based eco-friendly colors, or powder coated upon request.
- Possibility of welded hardened/self-sharpening blades upon request.

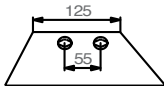
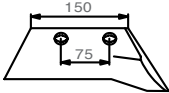
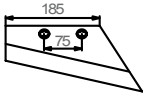
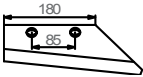
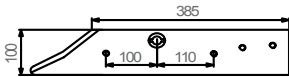
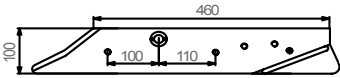
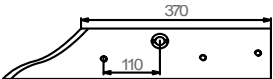
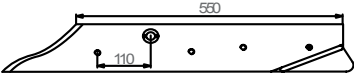
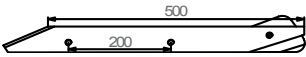
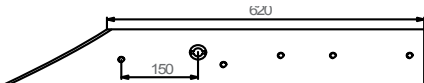
Image	No.	Original no.	Name
	0910	1903160, 002909D	Skim points
	0911	001847Z	Skim points: Right
	0912	001848Z	Skim points: Left
	0913	1903693, 037985D	Skim points: Right
	0914	1903694, 037986DD	Skim points: Left
	0915	1903695	Skim points: Right
	0916	1903695	Skim points: Left
	0917	000813Z	Short front landsides: Right
	0918	000814Z	Short front landsides: Left
	0919	000805Z	Long back landsides: Right
	0920	000806Z	Long back landsides: Left
	0921	001499Z, K-182	Short front landsides: Right
	0922	001500Z, K-192	Short front landsides: Left
	0923	001497Z, K-181	Long back landsides: Right
	0924	001498Z, K-181L	Long back landsides: Left
	0925	1903830	Long landsides: Right
	0926	1903840	Long landsides: Left
	0927	942.95.045.3 041225C	Landsides: Right
	0928	942.95.055.3 041226C	Landsides: Left

NOTE:

- All parts are made of B27 steel. It is possible to use other materials according to specific request.
- All parts are heat treated.
- Painting with water based eco-friendly colors, or powder coated upon request.
- Possibility of welded hardened/self-sharpening blades upon request.

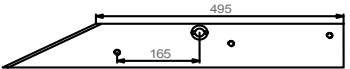
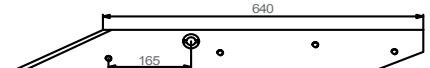
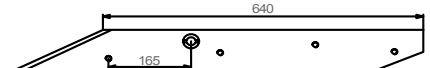
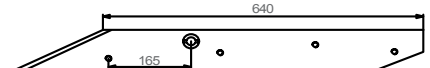
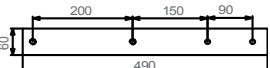
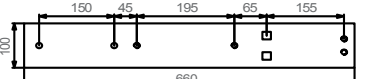
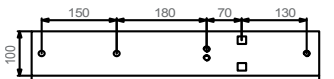
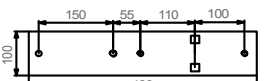
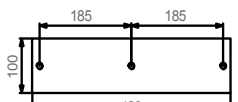
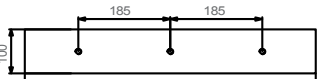
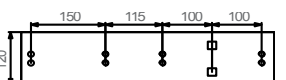
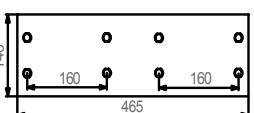
Image	No.	Original no.	Name
	0929	190 3569	Short landsides: Right
		190 3553	
	0930	190 3571	Short landsides: Left
		190 3554	
	0931	190 3567	Long landsides: Right
		190 3551	
	0932	190 3568	Long landsides: Left
		190 3552	
	0933	902.95.005.0	Landsides both: Right and: Left
	0934	041716Z	
	0935	940.95.005.0	Landsides both: Right and: Left
	0936	041791Z	
	0937	941.95.025.0	Landsides both: Right and: Left
		041869 Z	
	0938	902.95.025.0.	Landsides both: Right and: Left
	0939	041586Z	
	0940	940.95.025.0	Short landsides both: Right and: Left
	0941	041911Z	
	0942	940.95.026.0	Long landsides both: Right and: Left
	0943	041911Z	
	0944	941.95.045.0	Landsides both: Right and: Left
	0945	041534Z	
	0946	929.10.010.1	Landsides



NOTE:

- All parts are made of B27 steel. It is possible to use other materials according to specific request.
- All parts are heat treated.
- Painting with water based eco-friendly colors, or powder coated upon request.
- Possibility of welded hardened/self-sharpening blades upon request.

Image	No.	Original no.	Name
	0947	929.10.000.1	Landside tips: Right
	0948	929.10.005.1	Landside tips: Left
	0949	041232Z	Landside protections
	0950	041727Z	Landside protections
	0951	041793Z	Landside protections
	0952	041849Z	Landside protections
	0953	929.10.020.1	Landside protections
	0954	001463Z	Shin pieces: Right
	0955	001464Z	Shin pieces: Left
	0956	006770Z	Shin pieces: Right
	0957	006771Z	Shin pieces: Left
	0958	001765Z	Shin pieces: Right
	0959	001766Z	Shin pieces: Left
	0960	1903562, 041776Z	Shin pieces: Right
	0961	1903563, 041777Z	Shin pieces: Left

NOTE:

- All parts are made of B27 steel. It is possible to use other materials according to specific request.
- All parts are heat treated.
- Painting with water based eco-friendly colors, or powder coated upon request.
- Possibility of welded hardened/self-sharpening blades upon request.

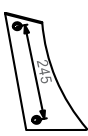
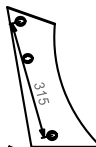
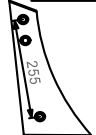
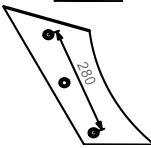
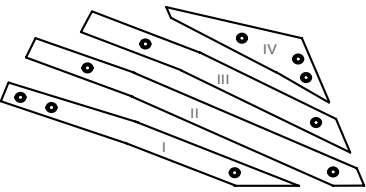
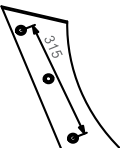
Image	No.	Original no.	Name
	0962	928.50.025.0	Shin pieces: Right
	0963	928.51.025.0	Shin pieces: Left
	0964	1903524, 041386Z	Shin pieces: Right
	0965	1903525, 041387Z	Shin pieces: Left
	0966	041584Z	Shin pieces: Right
	0967	041585Z	Shin pieces: Left
	0968	041820Z	Shin pieces: Right
	0969	041821Z	Shin pieces: Left
	0970	041884Z	Shin pieces: Right
	0971	041885Z	Shin pieces: Left
	0972	041218Z	Shin pieces: Right
	0973	041219Z	Shin pieces: Left
	0974	041506Z	Stripe R I below: right
	0975	041507Z	Stripe R II middle: right
	0976	041508Z	Stripe R III middle: right
	0977	041509Z	Stripe R IV above: right
	0978	041510Z	Stripe L I below: left
	0979	041511Z	Stripe L II middle: left
	0980	041512Z	Stripe L III middle: left
	0981	041513Z	Stripe L IV above: left
	0982	041532Z	Shin pieces: Right
	0983	041533Z	Shin pieces: Left



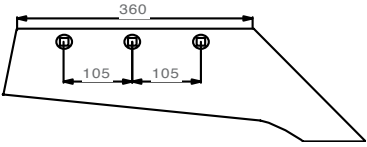
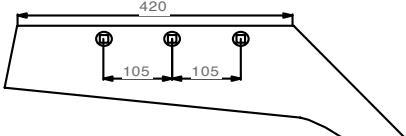
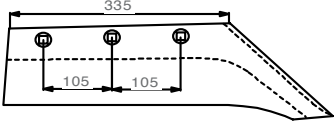
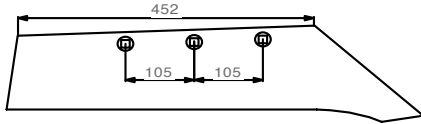
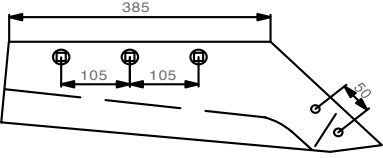
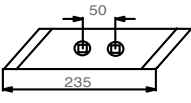
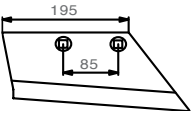
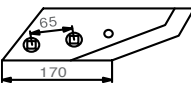
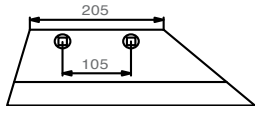
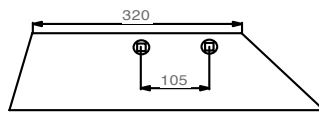

NOTE:

- All parts are made of B27 steel. It is possible to use other materials according to specific request.
- All parts are heat treated.
- Painting with water based eco-friendly colors, or powder coated upon request.
- Possibility of welded hardened/self-sharpening blades upon request.

Image	No.	Original no.	Name
	1010	333 3810	Beak shares: Right
	1011	333 3811	Beak shares: Left
	1012	333 3812	Beak shares: Right
	1013	333 3813	Beak shares: Left
	1014	333 3802	Beak shares: Right
	1015	333 3803	Beak shares: Left
	1016	334 4534	Beak shares: Right
	1017	334 4534	Beak shares: Left
	1018	333 4050	Shares for rev points: Right
	1019	333 4051	Shares for rev points: Left
	1020	336 5534	Reversible points: Right
	1021	336 5535	Reversible points: Left
	1022	335 3742	Share wings 12": Right
	1023	335 3743	Share wings 12": Left
	1024	336 3980	Share points: Right
	1025	336 3981	Share points: Left
	1026	335 1956	Shares 14": Right
	1027	335 1957	Shares 14": Left
	1028	335 1958	Share wings 16": Right
	1029	335 1959	Share wings 16": Left

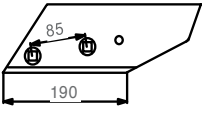
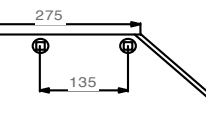
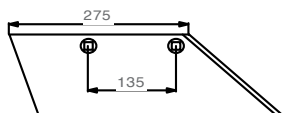
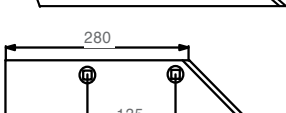
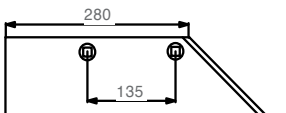
NOTE:

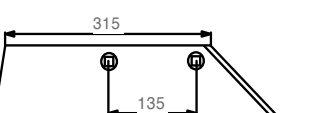
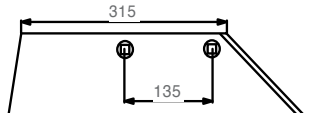
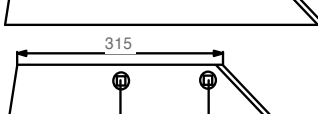
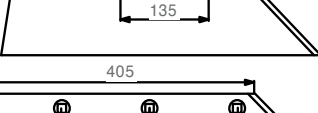
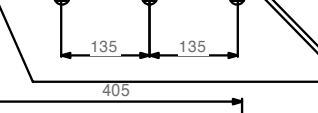
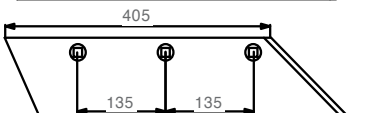
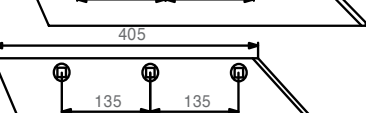
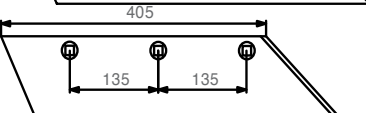
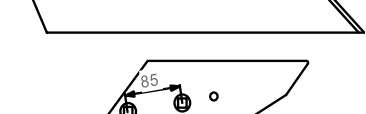
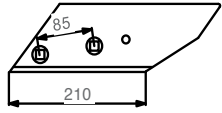
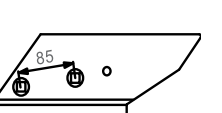
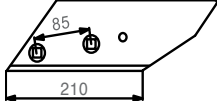
- All parts are made of B27 steel. It is possible to use other materials according to specific request.
- All parts are heat treated.
- Painting with water based eco-friendly colors, or powder coated upon request.
- Possibility of welded hardened/self-sharpening blades upon request.

Image	No.	Original no.	Name
	1030	336 3986	Share points: Right
	1031	336 3987	Share points: Left
	1032	335 2010	Share wings: Right
	1033	335 2011	Share wings: Left
	1034	335 2020	Share wings 16": Right
	1035	335 2021	Share wings 16": Left
	1036	335 2120	Share wings: Right
	1037	335 2121	Share wings: Left
	1038	335 2030	Share wings 18": Right
	1039	335 2031	Share wings 18": Left
	1040	335 2130	Share wings: Right
	1041	335 2131	Share wings: Left
	1042	335 2034	Share wings: Right
	1043	335 2035	Share wings: Left
	1044	335 2134	Share wings: Right
	1045	335 2135	Share wings: Left
	1046	336 4050	Share points: Right
	1047	336 4051	Share points: Left
	1048	336 4150	Share points: Right
	1049	336 4151	Share points: Left

NOTE:

- All parts are made of B27 steel. It is possible to use other materials according to specific request.
- All parts are heat treated.
- Painting with water based eco-friendly colors, or powder coated upon request.
- Possibility of welded hardened/self-sharpening blades upon request.

Image	No.	Original no.	Name
	1050	336 3710	Skim points: Right
	1051	336 3711	Skim points: Left
	1052	336 3712	Skim points: Right
	1053	336 3713	Skim points: Left
	1054	336 3720	Skim points: Right
	1055	336 3721	Skim points: Left
	1056	336 3714	Skim points: Right
	1057	336 3715	Skim points: Left
	1058	347 0600	Skimmer mouldboards: Right
	1059	347 0601	Skimmer mouldboards: Left
	1060	341 1828	Long landsides
	1061	341 1508	High landsides
	1062	340 1570	Short landsides
	1063	341 1450	Landsides
	1064	341 1460	Landsides



NOTE:

- All parts are made of B27 steel. It is possible to use other materials according to specific request.
- All parts are heat treated.
- Painting with water based eco-friendly colors, or powder coated upon request.
- Possibility of welded hardened/self-sharpening blades upon request.

Image	No.	Original no.	Name
	1065	341 1870	Landsides: Right
	1066	341 1871	Landsides: Left
	1067	340 1860	Landsides: Right
	1068	340 1861	Landsides: Left
	1069	341 1500	Landsides: Right
	1070	341 1504	Landsides: Left
	1071	340 1900	Landside tips: Right
	1072	340 1901	Landside tips: Left
	1073	340 1550	Landside protections
	1074	340 1490	Landside protections
	1075	345 1000	Shin pieces: Right
	1076	345 1001	Shin pieces: Left
	1077	345 0524	Shin pieces: Right
	1078	345 0525	Shin pieces: Left
	1079	345 1002	Shin pieces: Right
	1080	345 1003	Shin pieces: Left
	1081	345 1010	Shin pieces: Right
	1082	345 1011	Shin pieces: Left

NOTE:

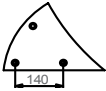
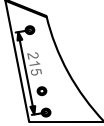
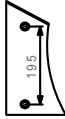
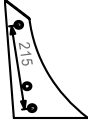
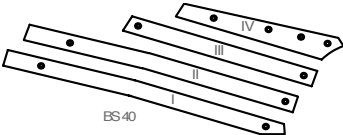
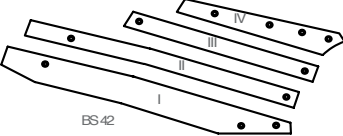
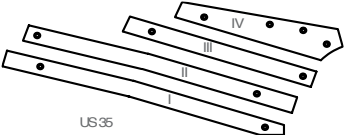
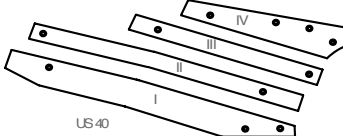
- All parts are made of B27 steel. It is possible to use other materials according to specific request.
- All parts are heat treated.
- Painting with water based eco-friendly colors, or powder coated upon request.
- Possibility of welded hardened/self-sharpening blades upon request.

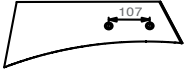
Image	No.	Original no.	Name
	1083	345 1004	Shin pieces: Right
	1084	345 1005	Shin pieces: Left
	1085	345 0532	Shin pieces: Right
	1086	345 0533	Shin pieces: Left
	1087	345 0498	Shin pieces: Right
	1088	345 0499	Shin pieces: Left
	1089	345 0528	Shin pieces: Right
	1090	345 0529	Shin pieces: Left
	1091	344 4010	Stripe IV: Right
	1092	344 4020	Stripe III: Right
	1093	344 4030	Stripe II: Right
	1094	344 4040	Stripe I: Right
	1095	344 4011	Stripe IV: Left
	1096	344 4021	Stripe III: Left
	1097	344 4031	Stripe II: Left
	1098	344 4041	Stripe I: Left
	1099	344 4110	Stripe IV: Right
	1100	344 4120	Stripe III: Right
	1101	344 4130	Stripe II: Right
	1102	344 4140	Stripe I: Right
	1103	344 4111	Stripe IV: Left
	1104	344 4121	Stripe III: Left
	1105	344 4131	Stripe II: Left
	1106	344 4141	Stripe I: Left
	1107	345 1002	Shin pieces: Right
	1108	345 1003	Shin pieces: Left
	1109	347 0860	Trashboards: Right
	1110	347 0861	Trashboards: Left

NOTE:

- All parts are made of B27 steel. It is possible to use other materials according to specific request.
- All parts are heat treated.
- Painting with water based eco-friendly colors, or powder coated upon request.
- Possibility of welded hardened/self-sharpening blades upon request.

Image	No.	Original no.	Name
	1111	349 2890	Sword landsides: Right
	1112	249 2891	Sword landsides: Left
	1113	337 4388	Share point
	1114	337 4395	Guide plate
	1115	313 6031	Pin D60x305/340 M60x2
	1116	313 4524	Pin D45x235/259 Zn
	1117	313 4033	Pin D40x241 Zn
	1118	433 9206	Locking piece

NOTE:

- All parts are made of B27 steel. It is possible to use other materials according to specific request.
- All parts are heat treated.
- Painting with water based eco-friendly colors, or powder coated upon request.
- Possibility of welded hardened/self-sharpening blades upon request.

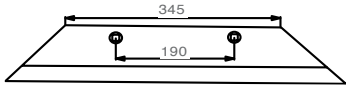
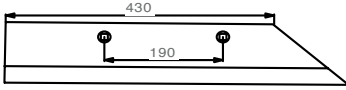
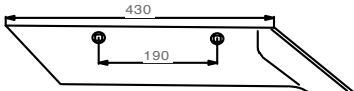
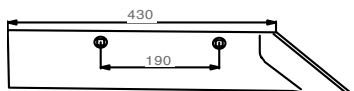
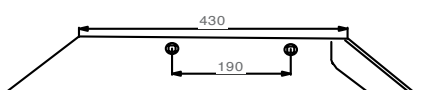
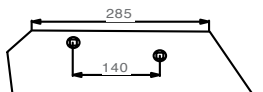
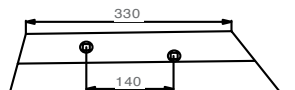
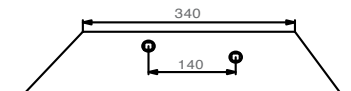
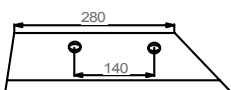
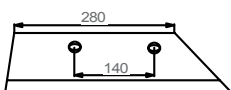
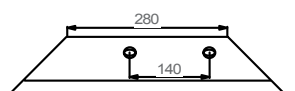
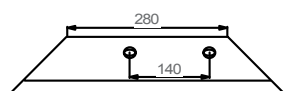
Image	No.	Original no.	Name
	1140	74 993	Beak shares to the both sides
	1141	74 991	Beak shares
	1142	74 902	Beak shares 12".
	1143	74 903	Beak shares 14"
	1144	74 904	Beak shares 16"
	1145	73 633, 58 542	Share wings 14": Right
	1146	74 606, 80 605 - 92	Share wings 14": Right
	1147	74 607	Share wings 16": Right
	1148	85 004, 85 003 16 585 00409	Share wings 12" / 14": Right
	1149	85 194, 85 193 16 585 19409	Share wings 12" / 14": Left
	1150	85 039 16 585 03909	Share wings 16": Right
	1151	85 195 16 585 19509	Share wings 16": Left



NOTE:

- All parts are made of B27 steel. It is possible to use other materials according to specific request.
- All parts are heat treated.
- Painting with water based eco-friendly colors, or powder coated upon request.
- Possibility of welded hardened/self-sharpening blades upon request.

Image	No.	Original no.	Name
	1152	84 958 16 584 95809	Fixation: Right
	1153	95 191 16 585 19109	Fixation: Left
	1154	92 206 165 922 0609	Share points: Right
	1155	92 207 165 922 0709	Share points: Left
	1156	85 383, 84 064 165 85 38 309	Share wings 14" / 16": Right
	1157	85 381, 84 078 165 85 38 109	Share wings 14" / 16": Left
	1158	85 384	Share wings 16": Right
	1159	85 382	Share wings 16": Left
	1160	84 288	Bracket plate: Right
	1161	84 289	Bracket plate: Left
	1162	94 588	Share wings 14": Right
	1163	94 599	Share wings 14": Left
	1164	96 090	Share wings 16": Right
	1165	96 091	Share wings 16": Left
	1166	94 600	Share wings 16": Right
	1167	94 601	Share wings 16": Left
	1168	96 092	Share wings 18": Right
	1169	96 093	Share wings 18": Left
	1170	94 602	Share wings 18": Right
	1171	94 603	Share wings 18": Left

NOTE:

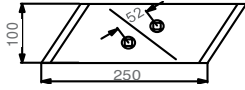
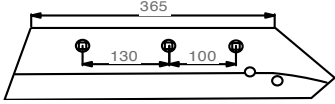
- All parts are made of B27 steel. It is possible to use other materials according to specific request.
- All parts are heat treated.
- Painting with water based eco-friendly colors, or powder coated upon request.
- Possibility of welded hardened/self-sharpening blades upon request.

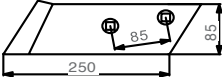
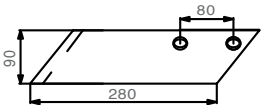
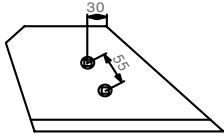
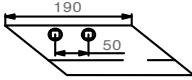
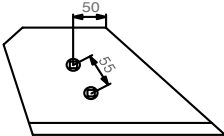
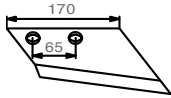
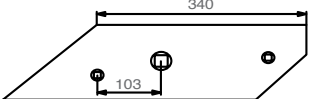
Image	No.	Original no.	Name
	1172	94 608	Share points: Right
	1173	94 609	Share points: Left
	1174	80521-92	Share wings 12" / 14": Right
	1175	80531-92	Share wings 12" / 14": Left
	1176	80 514	Share points: Right
	1177	80 543	Share points: Left
	1178	84 987	Share points: Right
	1179	85 206	Share points: Left
	1180	94 610	Share points: Right
	1181	94 611	Share points: Left
	1182	81 519	Skim points: Right
	1183	74 188, 80 644	Skim points: Right
	1184	80 639	Skim points: Left
	1185	86 322	Skim points: Right
	1186	86 323	Skim points: Left
	1187	93 055	Skim points: Right
	1188	93 054	Skim points: Left
	1189	57 997	Front landsides

NOTE:

- All parts are made of B27 steel. It is possible to use other materials according to specific request.
- All parts are heat treated.
- Painting with water based eco-friendly colors, or powder coated upon request.
- Possibility of welded hardened/self-sharpening blades upon request.

Image	No.	Original no.	Name
	1190	57998	Back landsides
	1191	86 291	Short landsides: Right
	1192	85 578	Short landsides: Left
	1193	85 202	Long landsides: Right
	1194	85 133	Long landsides: Left
	1195	71 857	Front landsides: Right
	1196	71 858	Back landsides: Right
	1197	74 943	Front landsides: Right
	1198	74 942	Back landsides: Right
	1199	74 602 80 602	Front landsides: Right
	1200	74 612 80 601	Back landsides: Right
	1201	80 505	Front landsides: Right
	1202	80 805	Front landsides: Left





NOTE:

- All parts are made of B27 steel. It is possible to use other materials according to specific request.
- All parts are heat treated.
- Painting with water based eco-friendly colors, or powder coated upon request.
- Possibility of welded hardened/self-sharpening blades upon request.

Image	No.	Original no.	Name
	1203	80 546	Back landsides: Right
	1204	80 547	Back landsides: Left
	1205	83 981	Front landsides: Right
	1206	85 196	Front landsides: Left
	1207	85 118	Back landsides: Right
	1208	85 197	Back landsides: Left
	1209	94 604	Landsides: Right
	1210	94 605	Landsides: Left
	1211	84 239	Short landsides: Right
	1212	94 289	Landsides protections
	1213	63 600A	Landside protectionts to the both sides
	1214	63 601A	Landside protectionts to the both sides
	1215	71 850	Shin pieces
	1216	80 512	Shin pieces: Right
	1217	80 513	Shin pieces: Left

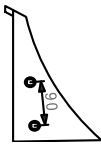
NOTE:

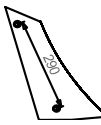
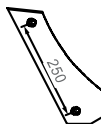
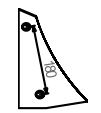
- All parts are made of B27 steel. It is possible to use other materials according to specific request.
- All parts are heat treated.
- Painting with water based eco-friendly colors, or powder coated upon request.
- Possibility of welded hardened/self-sharpening blades upon request.

Image	No.	Original no.	Name
	1218	71 850	Shin pieces
	1219	84 033, 1658403309	Shin pieces: Right
	1220	84 082, 1658408209	Shin pieces: Left
	1221	96 086	Shin pieces: Right
	1222	96 087	Shin pieces: Left
	1223	83 980	Shin pieces: Right
	1224	84 083	Shin pieces: Left
	1225	94 596	Shin pieces: Right
	1226	94 507	Shin pieces: Left
	1227	74 871 80 609	Shin pieces: Right

NOTE:

- All parts are made of B27 steel. It is possible to use other materials according to specific request.
- All parts are heat treated.
- Painting with water based eco-friendly colors, or powder coated upon request.
- Possibility of welded hardened/self-sharpening blades upon request.

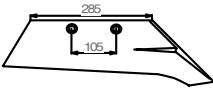
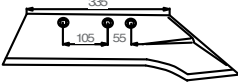
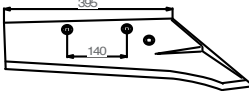
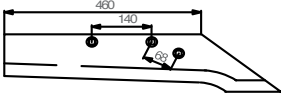
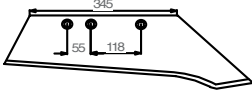
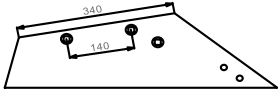
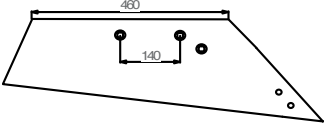
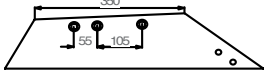
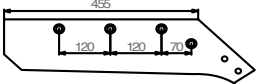
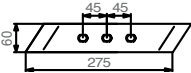
Image	No.	Original no.	Name
	1250	SP 200 JB	Beak shares: Right
	1251	SP 200 JB	Beak shares: Left
	1252	SSP 290-R	Beak shares: Right
	1253	SSP 293-O	Beak shares: Right
	1254	SSP 293-OL	Beak shares: Left
	1255	SSP 294-OR	Beak shares: Right
	1256	SSP 294-OL	Beak shares: Left
	1257	SSP 331-O	Beak shares: Right
	1258	SSP 331-OL	Beak shares: Left
	1259	SSP 293-OS	Shares for rev. points: Right
	1260	SSP 293-OSL	Shares for rev. points: Left
	1261	SSP 294-OS	Shares for rev. points: Right
	1262	SSP 294-OSL	Shares for rev. points: Left
	1263	SSP 332-OS	Shares for rev. points: Right
	1264	SSP 332-OSL	Shares for rev. points: Left
	1265	SSP 350-WS	Shares for rev. points: Right
	1266	SSP 350-WSL	Shares for rev. points: Left
	1267	MP 293	Reversible points: Right
	1268	MP 293L	Reversible points: Left

NOTE:

- All parts are made of B27 steel. It is possible to use other materials according to specific request.
- All parts are heat treated.
- Painting with water based eco-friendly colors, or powder coated upon request.
- Possibility of welded hardened/self-sharpening blades upon request.

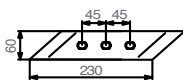
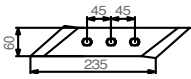
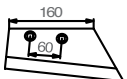
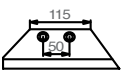
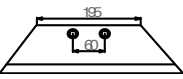
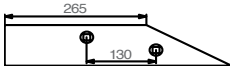
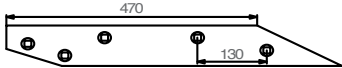
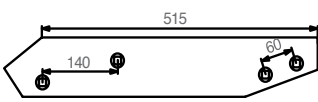
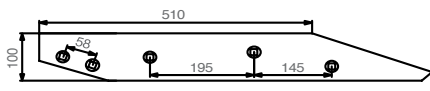
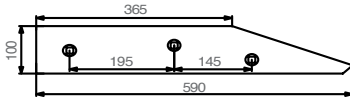
Image	No.	Original no.	Name
	1269	MP 332	Reversible points: Right
	1270	MP 332L	Reversible points: Left
	1271	MP 350	Reversible points: Right
	1272	MP 350L	Reversible points: Left
	1273	SDG 181	Skim points: Right
	1274	SDG 181	Skim points: Left
	1275	SDG 14/16	Skim points: Right
	1276	SDG 14/16L	Skim points: Left
	1277	SDG 18 BR	Skim points: Right
	1278	SDG 18 BL	Skim points: Left
	1279	VP-202-0	Short landsides, to the both sides (Right and Left)
	1280	WP-203-0	Long landsides, to the both sides (Right and Left)
	1281	WP-290-O	Landsides: Right
	1282	WP-290-OL	Landsides: Left
	1283	WP-292-0	Long landsides, to the both sides (Right and Left)
	1284	VP-292-0	Short landsides, to the both sides (Right and Left)





NOTE:

- All parts are made of B27 steel. It is possible to use other materials according to specific request.
- All parts are heat treated.
- Painting with water based eco-friendly colors, or powder coated upon request.
- Possibility of welded hardened/self-sharpening blades upon request.

Image	No.	Original no.	Name
	1285	VP 350 W	Landsides to the both sides (Right and Left)
	1286	WP 300	Long landsides to the both sides (Right and Left)
	1287	VP 300	Short landsides to the both sides (Right and Left)
	1288	WP 351 W	Landsides to the both sides (Right and Left)
	1289	VP 351 W	Landsides to the both sides (Right and Left)
	1290	XP - 6	Landside pprotections
	1291	XP - 4	Landside pprotections
	1292		Landside pprotections woth screws
	1293	VRP 230/0	Shin pieces: Right
	1294	VRP 230/0 L	Shin pieces: Left
	1295	VRP 292 R	Shin pieces: Right
	1296	VRP 292 L	Shin pieces: Left

NOTE:

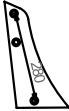
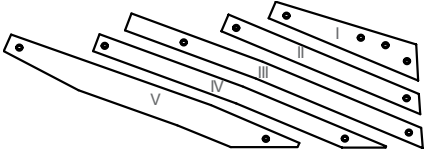
- All parts are made of B27 steel. It is possible to use other materials according to specific request.
- All parts are heat treated.
- Painting with water based eco-friendly colors, or powder coated upon request.
- Possibility of welded hardened/self-sharpening blades upon request.

Image	No.	Original no.	Name
	1297	VRP 290-O	Shin pieces: Right
	1298	VRP 290-OL	Shin pieces: Left
	1299	VRP 330	Shin pieces: Right
	1300	VRP 330 L	Shin pieces: Left
	1301	VRP 35 OW	Shin pieces: Right
	1302	VRP 35 OW L	Shin pieces: Left
	1303	VRP 342 R	Shin pieces: Right
	1304	VRP 342 R L	Shin pieces: Left
	1305	VRP 3420	Shin pieces: Right
	1306	VRP 3420 L	Shin pieces: Left
	1307	SRP 328 P1	Slats I: Right
	1308	SRP 328 P2	Slats II: Right
	1309	SRP 328 P3	Slats III: Right
	1310	SRP 328 P4	Slats IV: Right
	1311	SRP 327 PB4	Slats V: Right
	1312	SRP 328 PL1	Slats I: Left
	1313	SRP 328 PL2	Slats II: Left
	1314	SRP 328 PL3	Slats III: Left
	1315	SRP 328 PL4	Slats IV: Left
	1316	SRP 327 PBL4	Slats V: Left
	1317	VRP 342 R	Shin pieces: Right
	1318	VRP 342 RL	Shin pieces: Left

NOTE:

- All parts are made of B27 steel. It is possible to use other materials according to specific request.
- All parts are heat treated.
- Painting with water based eco-friendly colors, or powder coated upon request.
- Possibility of welded hardened/self-sharpening blades upon request.

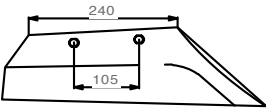
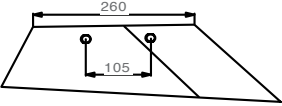
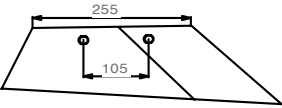
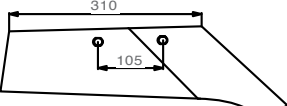
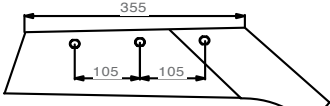
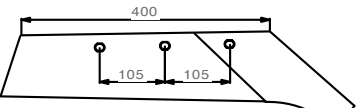
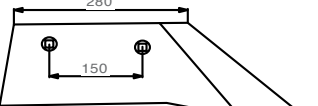
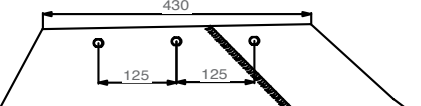
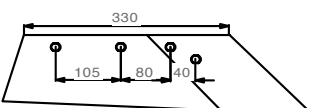
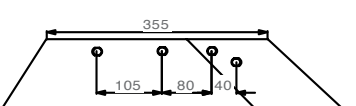
Image	No.	Original no.	Name
	1340	DU 26 R	Pointed shares: Right
	1341	DU 26 L	Pointed shares: Left
	1342	DU 28 SR	Pointed shares: Right
	1343	DU 28 SL	Pointed shares: Left
	1344	DU 29 SR	Pointed shares: Right
	1345	33.18.180 DU 29 SL 33.18.196	Pointed shares: Left
	1346	DU 30 SR	Beak shares: Right
	1347	33.18.212 DU 30 SL 33.18.228	Beak shares: Left
	1348	DU 35 SR, DU 33	Beak shares: Right
	1349	33.18.276 DU 35 SL, DU 33 33.18.292	Beak shares: Left
	1350	DU 40 SR	Beak shares: Right
	1351	33.18.308 DU 40 SL 33.18.332	Beak shares: Left
	1352	SPK 30	Beak shares: Right with spines for reforging
	1353	DU 42 R	Beak shares: Right
	1354	33.18.332	
	1355	DU 433 SR	Beak shares: Right
	1356	33.18.340 DU 433 SL 33.18.356	Beak shares: Left
	1357	DU 435 SR	Beak shares: Right
	1358	33.18.372 DU 435 SL 33.18.388	Beak shares: Left

NOTE:

- All parts are made of B27 steel. It is possible to use other materials according to specific request.
- All parts are heat treated.
- Painting with water based eco-friendly colors, or powder coated upon request.
- Possibility of welded hardened/self-sharpening blades upon request.

Image	No.	Original no.	Name
	1359	DU 440 SR 33.18.404	Beak shares: Right
	1360	DU 440 SL 33.18.420	Beak shares: Left
	1361	DU 445 SR 33.18.436	Beak shares: Right
	1362	DU 445 SL 33.18.452	Beak shares: Left
	1363	SN 640 R 33.18.641	Beak shares: Right
	1364	SN 640 L 33.18.642	Beak shares: Left
	1365	SW 640 R 33.18.661	Shares for rev. points: Right
	1366	SW 640 L 33.18.662	Shares for rev. points: Left
	1367	DW 30 SR	Shares for rev. points: Right
	1368	DW 30 SL	Shares for rev. points: Left
	1369	DW 35 SR 33.21.180 G	Shares for rev. points: Right
	1370	DW 35 SL 33.21.196 G	Shares for rev. points: Left
	1371	DW 40 SR 33.21.212 G	Shares for rev. points: Right
	1372	DW 40 SL 33.21.228 G	Shares for rev. points: Left
	1373	DW 435 SR 33.21.244 G	Shares for rev. points: Right
	1374	DW 435 SL 33.21.260 G	Shares for rev. points: Left
	1375	DW 440 SR 33.21.276 G	Shares for rev. points: Right
	1376	DW 440 SL 33.21.292 G	Shares for rev. points: Left
	1377	DW 445 SR 33.21.308 G	Shares for rev. points: Right
	1378	DW 445 SL 33.21.324 G	Shares for rev. points: Left

NOTE:

- All parts are made of B27 steel. It is possible to use other materials according to specific request.
- All parts are heat treated.
- Painting with water based eco-friendly colors, or powder coated upon request.
- Possibility of welded hardened/self-sharpening blades upon request.

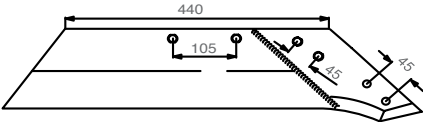
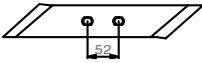
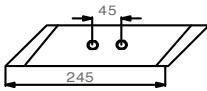
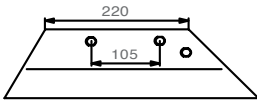
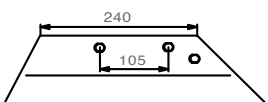
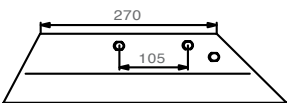
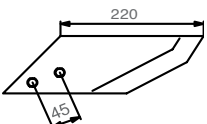
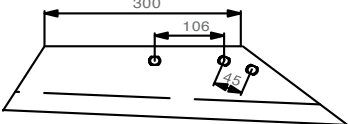
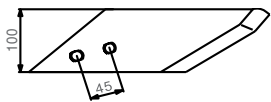
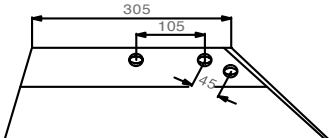
Image	No.	Original no.	Name
	1379	DW 720 R 33.21.340 G	Shares for rev. points: Right
	1380	DW 720 L 33.21.356 G	Shares for rev. points: Left
	1381	SWS 600 R 33.18.601	Reversible points: Right
	1382	SWS 600 L 33.18.602	Reversible points: Left
	1383	DWS-R 33.21.116	Spinning reversible points: Right
	1384	DWS-L 33.21.132	Spinning reversible points: Left
	1385	DG 535 R, DG 533 535 50 20 - 1	Share wings: Right
	1386	DG 535 L, DG 533 535 50 20 - 2	Share wings: Left
	1387	DG 540 R 540 50 20 - 1	Share wings: Right
	1388	DG 540 L 540 50 20 - 2	Share wings: Left
	1389	DG 545 R 545 50 20 - 1	Share wings: Right
	1390	DG 545 L 545 50 20 - 2	Share wings: Left
	1391	DGS 500 R 500 50 10 - 1	Share points: Right
	1392	DGS 500 L 500 50 10 - 2	Share points: Left
	1393	DG 720 R 33.30.388	Share wings: Right
	1394	DG 720 L 33.30.420	Share wings: Left
	1395	DGS 700 R 33.33.292	Share points: Right
	1396	DGS 700 L 33.33.356	Share points: Left
	1397	DG 774 R 33.21.380	Share wings: Right
	1398	DG 774 L 33.21.384	Share wings: Left

NOTE:

- All parts are made of B27 steel. It is possible to use other materials according to specific request.
- All parts are heat treated.
- Painting with water based eco-friendly colors, or powder coated upon request.
- Possibility of welded hardened/self-sharpening blades upon request.

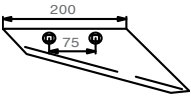
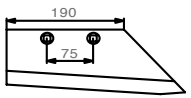
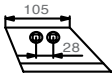
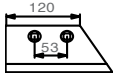
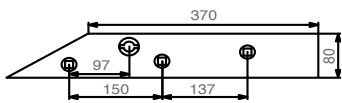
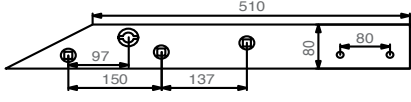
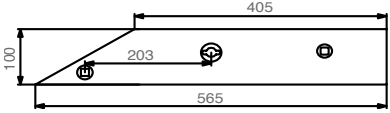
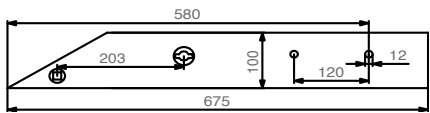
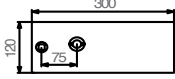
Image	No.	Original no.	Name
	1399	DGS 770 R 33.21.370	Share points: Right
	1400	DGS 770 L 33.21.374	Share points: Left
	1401	MS-R, 33.27.196 GS-R, 33.27.132	Skim points: Right
	1402	MS-L, 33.27.164 GS-L, 33.27.228	Skim points: Left
	1403	VS = 512 R 33.27.260	Skim points: Right
	1404	VS = 512 L 33.27.292	Skim points: Left
	1405	DS 29	Skim points: Right
	1406	DS 29 L	Skim points: Left
	1407	DS 53 501.00.03.1	Skim points: Right
	1408	DS 53 L 501.00.03.2	Skim points: Left
	1409	037 10 05 - 1	Front landsides: Right
	1410	037 10 05 - 2	Front landsides: Left
	1411	037 10 06 - 1	Back landsides: Right
	1412	037 10 06 - 2	Back landsides: Left
	1413	432 01 15 - 1	Front landsides: Right (Saturn)
	1414	432 01 15 - 2	Front landsides: Left (Uranus, Pluto)
	1415	170 02 11 - 1	Back landsides: Right
	1416	170 02 11 - 2	Back landsides: Left
	1417	044 06 08 - 1	Front landsides: Right

NOTE:

- All parts are made of B27 steel. It is possible to use other materials according to specific request.
- All parts are heat treated.
- Painting with water based eco-friendly colors, or powder coated upon request.
- Possibility of welded hardened/self-sharpening blades upon request.

Image	No.	Original no.	Name
	1418	044 07 01 - 1	Back landsides: Right
	1419	034 05 06 - 1	Front landsides: Right / Left
	1420	034 06 01 - 1	Back landsides: Right
	1421	160 01 18 - 1	Front landsides: Right
	1422	160 01 18 - 2	Front landsides: Left
	1423	160 02 15 - 1	Back landsides: Right
	1424	160 02 15 - 2	Back landsides: Left
	1425	490 41 12 1	Landsides: Right
	1426	490 41 12 2	Landsides: Left
	1427	165 01 17 - 1	Front landsides: Right
	1428	160061-1, 165 01 11 - 1 165 01 17 - 2 1600611-2, 165.01.11-2	Front landsides: Left
	1429	227 01 14 - 1 165.02.19 - 1	Back landsides: Right
	1430	227 01 14 - 2 165.02.19 - 2	Back landsides: Left
	1431	495.42.11.1	Front landsides: Right
	1432	495.42.11.2	Front landsides: Left
	1433	495.42.13.1	Back landsides: Right
	1434	495.42.13.2	Back landsides: Left

NOTE:

- All parts are made of B27 steel. It is possible to use other materials according to specific request.
- All parts are heat treated.
- Painting with water based eco-friendly colors, or powder coated upon request.
- Possibility of welded hardened/self-sharpening blades upon request.

Image	No.	Original no.	Name
	1435	GNV 013.04.07	Front sole blocks
	1436	AP 1, 034.06.02	Landside protections: on the both sides (Right and Left)
	1437	AP 3, 160.02.11	Landside protections: on the both sides (Right and Left)
	1438	AP 4, 162.02.011	Landside protections: on the both sides (Right and Left)
	1439	AP 5, 4320211	Landside protections: Right
	1440	AP 5 L	Landside protections: Left
	1441	1600214, 1600213	Landside protections: on the both sides (Right and Left)
	1442	1700213, 1700212	Landside protections: on the both sides (Right and Left)
	1443	170.02.21	Landside protections: on the both sides (Right and Left)
	1444	160.02.20	Landside protections: on the both sides (Right and Left)
	1445	227.01.15	Landside protections: Right
	1446	227.01.14	Landside protections: Left

NOTE:

- All parts are made of B27 steel. It is possible to use other materials according to specific request.
- All parts are heat treated.
- Painting with water based eco-friendly colors, or powder coated upon request.
- Possibility of welded hardened/self-sharpening blades upon request.

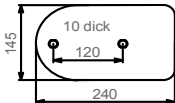
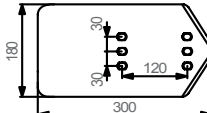
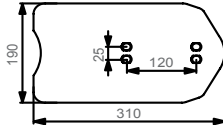
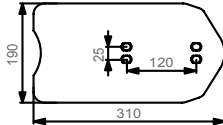
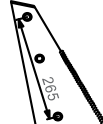
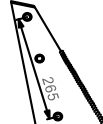
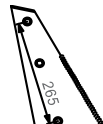
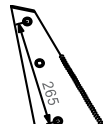
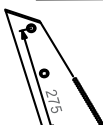
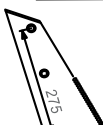
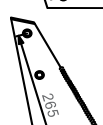
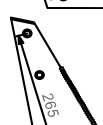
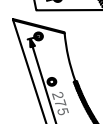
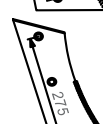
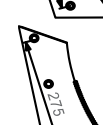
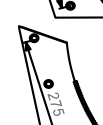
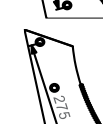
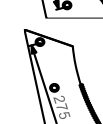
Image	No.	Original no.	Name
	1447	490.41.11	Landside protections
	1448	493.10.11	Landside plates
	1449	495.42.12	Landside plates: Right
	1450	495.42.13	Landside plates: Left
	1451	AS-WSR 4320117.1, 4320119.1	Shin pieces: Right
	1452	AS-WSL 4320117.2, 4320119.2	Shin pieces: Left
	1453	AS-WSR 4320117.1, 4320119.1	Shin pieces: Right
	1454	AS-WSL 4320117.2, 4320119.2	Shin pieces: Left
	1455	MU+ASR 435.01.15.1	Shin pieces: Right
	1456	MU+ASL 435.01.015.2	Shin pieces: Left
	1457	AS-WS 4320117.1, 4320119.1	Shin pieces: Right
	1458	AS-WS 4320117.2, 4320119.2	Shin pieces: Left
	1459	AS-W 4 R 495.38.20.1	Shin pieces: Right
	1460	AS-W 4 L 495.38.20.2	Shin pieces: Left
	1461	AS-MK R 226.01.26.1	Shin pieces: Right
	1462	AS-MK L 226.01.26.2	Shin pieces: Left
	1463	AS-MK R 226.01.26.1	Shin pieces: Right
	1464	AS-MK L 226.01.26.2	Shin pieces: Left

NOTE:

- All parts are made of B27 steel. It is possible to use other materials according to specific request.
- All parts are heat treated.
- Painting with water based eco-friendly colors, or powder coated upon request.
- Possibility of welded hardened/self-sharpening blades upon request.

Image	No.	Original no.	Name
	1465	WU 26	Shin pieces: Right
	1466	WUL 26	Shin pieces: Left
	1467	WU 28	Shin pieces: Right
	1468	WUL 28	Shin pieces: Left
	1469	MU-WS	Shin pieces: Right
	1470	MU-WS L	Shin pieces: Left
	1471	MU+MS R 435.01.15.1	Shin pieces: Right
	1472	MU+MS L 435.01.15.2	Shin pieces: Left
	1473	AS-WSR 4320119.1 4320117.1	Shin pieces: Right
	1474	AS-WSL 4320119.2 4320117.2	Shin pieces: Left
	1475	AS-MUR AS 435.01.15.1	Shin pieces: Right
	1476	AS-MUL AS 435.01.15.2	Shin pieces: Left
	1477	AS-W 4R AS 495.38.13.1	Shin pieces: Right
	1478	AS-W 4L AS 495.38.13.2	Shin pieces: Left
	1479	AS-W 4R AS 497.40.20.1	Shin pieces: Right
	1480	AS-W 4L AS 497.40.20.2	Shin pieces: Left
	1481	AS-W 5R AS 565.35.13.1	Shin pieces: Right
	1482	AS-W 5L AS 565.35.13.2	Shin pieces: Left
	1483	AS-MK AS 226.01.21.1	Shin pieces: Right
	1484	AS-MK AS 226.01.21.2	Shin pieces: Left

NOTE:

- All parts are made of B27 steel. It is possible to use other materials according to specific request.
- All parts are heat treated.
- Painting with water based eco-friendly colors, or powder coated upon request.
- Possibility of welded hardened/self-sharpening blades upon request.

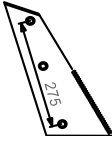
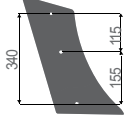
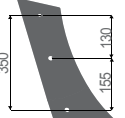
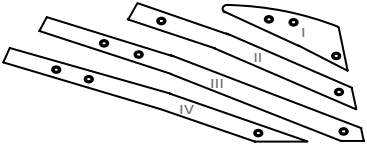
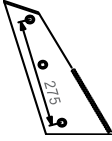
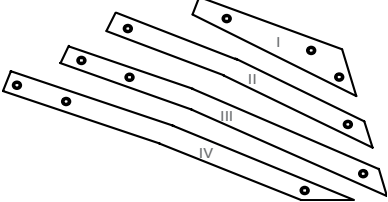
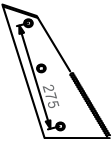
Image	No.	Original no.	Name
	1485	AS-SKL 5 AS 575.40.15.1	Shin pieces: Right
	1486	AS-SKL 5 AS 575.40.15.1	Shin pieces: Left
	1487	AS-W 5R AS 567.33.13.1	Shin pieces: Right
	1488	AS-W 5L AS 567.33.13.2	Shin pieces: Left
	1489	AS-HL R AS 720.40.13.1	Shin pieces: Right
	1490	AS-HL L AS 720.40.13.2	Shin pieces: Left
	1491	425.01.11-1	Stripe I: Right
	1492	425.01.19-1	Stripe II: Right
	1493	425.01.20-1	Stripe III: Right
	1494	425.01.21-1	Stripe IV below: Right
	1495	425.01.11-2	Stripe I: Left
	1496	425.01.19-2	Stripe II: Left
	1497	425.01.20-2	Stripe III: Left
	1498	425.01.21-2	Stripe IV below: Left
	1499	MU, ASR 435.01.15.1	Shin pieces: Right
	1500	MU, ASL 435.01.15.2	Shin pieces: Left
	1501	575.40.111	Stripe I: Right
	1502	575.40.121	Stripe II: Right
	1503	490.40.16-1	Stripe III: Right
	1504	490.40.17-1	Stripe IV: Right
	1505	575.40.112	Stripe I: Left
	1506	575.40.122	Stripe II: Left
	1507	490.40.16-2	Stripe III: Left
	1508	490.40.17-2	Stripe IV: Left
	1509	AS-SKL 5 R AS 576.42.16.1	Shin pieces: Right
	1510	AS-SKL 5 L AS 576.42.16.2	Shin pieces: Left

NOTE:

- All parts are made of B27 steel. It is possible to use other materials according to specific request.
- All parts are heat treated.
- Painting with water based eco-friendly colors, or powder coated upon request.
- Possibility of welded hardened/self-sharpening blades upon request.

Image	No.	Original no.	Name
	1511	575.40.11-1	Stripe I: Right
	1512	575.40.12-1	Stripe II: Right
	1513	575.40.30-1	Stripe III: Right
	1514	575.40.31-1	Stripe IV: Right
	1515	575.40.11-2	Stripe I: Left
	1516	575.40.12-2	Stripe II: Left
	1517	575.40.30-2	Stripe III: Left
	1518	575.40.31-2	Stripe IV: Left
	1519	AS-SKL 5	Shin pieces: Right
	1520	AS 575.40.151	
	1521	AS-SKL 5	Shin pieces: Left
	1522	AS 575.40.152	

NOTE:

- All parts are made of B27 steel. It is possible to use other materials according to specific request.
- All parts are heat treated.
- Painting with water based eco-friendly colors, or powder coated upon request.
- Possibility of welded hardened/self-sharpening blades upon request.

Parts for:



ROSS (PHX, AGROZET)



Image	No.	Original no.	Name
	1550		Shares for reversible points PHX: Right
	1551		Reversible points PHX: Right
	1552		Long landsides
	1553		Short landsides

NOTE:

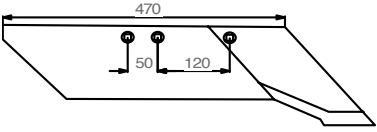
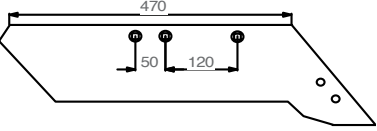
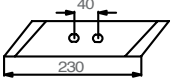
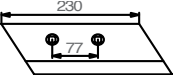
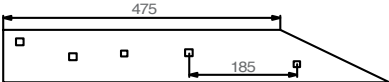
- All parts are made of B27 steel. It is possible to use other materials according to specific request.
- All parts are heat treated.
- Painting with water based eco-friendly colors, or powder coated upon request.
- Possibility of welded hardened/self-sharpening blades upon request.

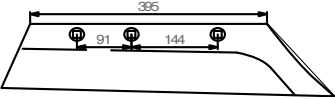
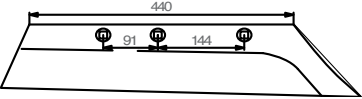
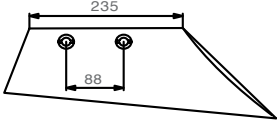
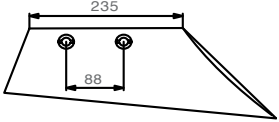
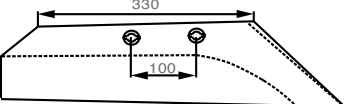
Image	No.	Original no.	Name
	1580 1581	93 002, CA 14 93 001, CA 12	Beak shares 14"
	1582	93 114	Shares for rev. points
	1583	093 105	Reversible points: Right
	1584	096 552, 2297	Skim points
	1585	093 650, FA28LH	Long back landsides
	1586	M 300	Beak shares
	1587	M 350	Pointed shares
	1588	SM 400	Pointed shares: Right
	1589	WS 275 P51.01.05	Pointed shares: Right
	1590	WS 275 P51.02.05	Pointed shares: Left
	1591	M 300 S P60.01.01	Pointed shares: Right



NOTE:

- All parts are made of B27 steel. It is possible to use other materials according to specific request.
- All parts are heat treated.
- Painting with water based eco-friendly colors, or powder coated upon request.
- Possibility of welded hardened/self-sharpening blades upon request.

Image	No.	Original no.	Name
	1592	M 300 P	Pointed shares: Right
	1593	P54.001.03	
	1594	M 350 P PK9.000.01	Pointed shares: Right
	1595	M 350 P PK9.000.02	Pointed shares: Left
	1596	WSU 350	Beak shares: Right
	1597	P59.01.01	
	1598	P95.001.01	Beak shares: Right
	1599	W 275 P50.01.03	Beak shares: Right
	1600	W 275 P50.02.03	Beak shares: Left
	601	W 300 P P52.001.04	Beak shares: Right
	1602	W 300 P P52.002.04	Beak shares: Left
	1603	WSU 300 P58.01.01	Beak shares: Right
	1604	WSU 300 P58.02.01	Beak shares: Left
	1605	M 400 P PK9.000.03	Pointed shares: Right
	1606	M 400 P PK9.000.04	Pointed shares: Left

NOTE:

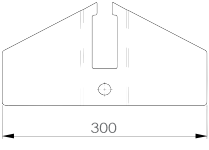
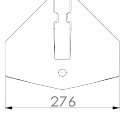
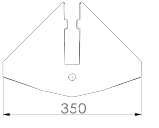
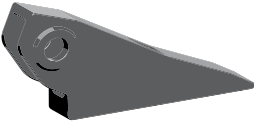
- All parts are made of B27 steel. It is possible to use other materials according to specific request.
- All parts are heat treated.
- Painting with water based eco-friendly colors, or powder coated upon request.
- Possibility of welded hardened/self-sharpening blades upon request.

Image	No.	Original no.	Name
	1630	P09060	Low wing
	1631	P10392	Wing
	1632	P10411	Wide wing
	1633	P09148	Subsoil point
	1634	P10391	Shin

NOTE:

- All parts are made of B27 steel. It is possible to use other materials according to specific request.
- All parts are heat treated.
- Painting with water based eco-friendly colors, or powder coated upon request.
- Possibility of welded hardened/self-sharpening blades upon request.

Parts for:

VÄDERSTADT



Image	No.	Original no.	Name
	1660	449 859 R	Topdown wing: Right
	1661	449 859 L	Topdown wing: Left
	1662	430 400	Wear plate
	1663	419 998	Wear plate
	1664	303 064	Washer plate
	1665	411 746	Rubber shock absorber bar
	1666	432 117	Seed coulter: Right
	1667	432 116	Seed coulter: Left
	1668	440 488	Bearing hub

NOTE:

- All parts are made of B27 steel. It is possible to use other materials according to specific request.
- All parts are heat treated.
- Painting with water based eco-friendly colors, or powder coated upon request.
- Possibility of welded hardened/self-sharpening blades upon request.

Image	No.	Original no.	Name
	1669	470 974	Bearing hub
	1670	419 996 - 1	Wear pad
	1671	478 273	Hydraulic cilinder
	1672	307 190 H	Pin
	1673	191 003	Pin
	1674	444 898	Topdown reversible point
	1675	482 278	Guide
	1676	452 680	Bearing
	1677	467 564	Bearing
	1678	447 709	Bearing

NOTE:

- All parts are made of B27 steel. It is possible to use other materials according to specific request.
- All parts are heat treated.
- Painting with water based eco-friendly colors, or powder coated upon request.
- Possibility of welded hardened/self-sharpening blades upon request.

Parts for:

VÄDERSTADT

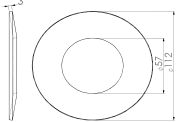
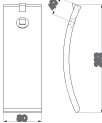
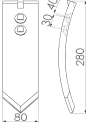
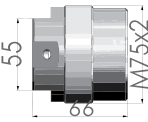

Image	No.	Original no.	Name
	1678	451 404	Cleaner
	1679	401 444	Spring plate
	1680	452 854	Point
	1681 1682	155 028 013 719	Point
	1683	422 418	Hub

NOTE:

- All parts are made of B27 steel. It is possible to use other materials according to specific request.
- All parts are heat treated.
- Painting with water based eco-friendly colors, or powder coated upon request.
- Possibility of welded hardened/self-sharpening blades upon request.

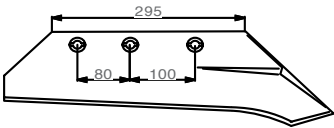
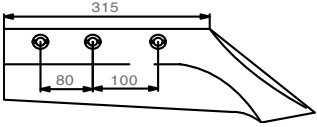
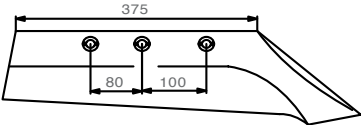
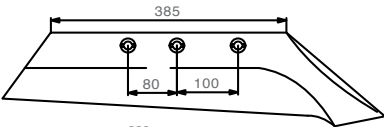
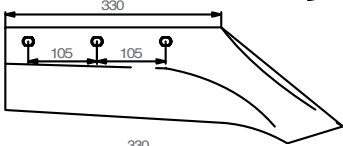
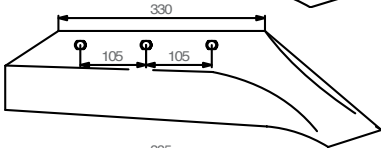
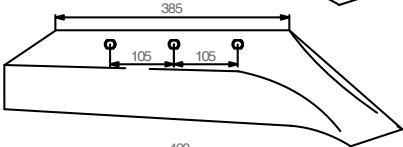
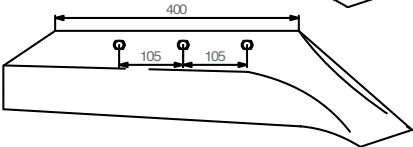
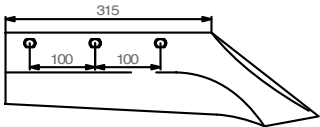
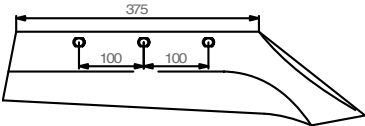
Image	No.	Original no.	Name
	1710	WY 25 P93.001.01	Beak shares: Right
	1711	WY 25 P93.002.01	Beak shares: Left
	1712	WY 3000 P93.030.01	Beak shares: Right
	1713	WY 3000 P93.031.01	Beak shares: Left
	1714	WY 3500 P93.030.02	Beak shares: Right
	1715	WY 3500 P93.031.02	Beak shares: Left
	1716	WY 4000 P93.030.03	Beak shares: Right
	1717	WY 4000 P93.031.03	Beak shares: Left
	1718	PK2.001.01	Beak shares: Right
	1719	PK2.002.01	Beak shares: Left
	1720	PK3.001.01	Beak shares: Right
	1721	PK3.002.01	Beak shares: Left
	1722	PK4.001.01	Beak shares: Right
	1723	PK4.002.01	Beak shares: Left
	1724	PK5.001.01	Beak shares: Right
	1725	PK5.002.01	Beak shares: Left
	1726	PK0.000.01	Beak shares: Right
	1727	PK0.000.02	Beak shares: Left
	1728	PK0.000.03	Beak shares: Right
	1729	PK0.000.04	Beak shares: Left

NOTE:

- All parts are made of B27 steel. It is possible to use other materials according to specific request.
- All parts are heat treated.
- Painting with water based eco-friendly colors, or powder coated upon request.
- Possibility of welded hardened/self-sharpening blades upon request.

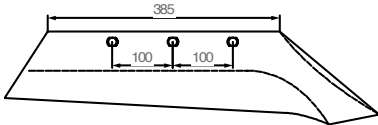
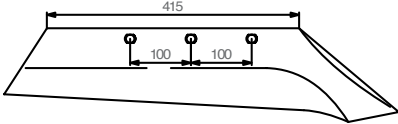
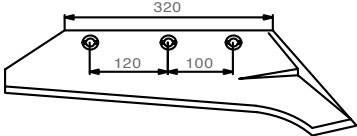
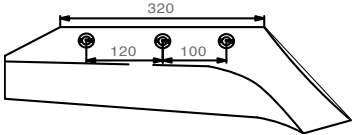
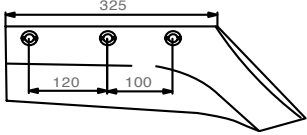
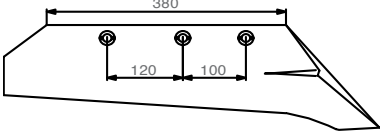
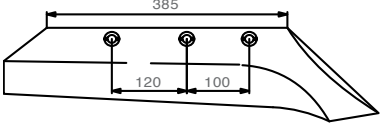
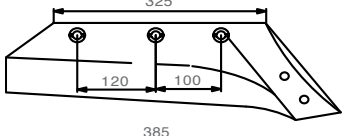
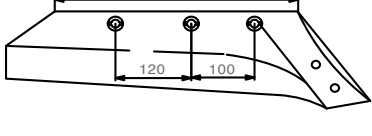
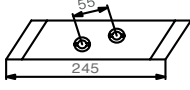
Image	No.	Original no.	Name
	1730	PK0.000.05	Beak shares: Right
	1731	PK0.000.06	Beak shares: Left
	1732	PK0.000.07	Beak shares: Right
	1733	PK0.000.08	Beak shares: Left
	1734	U 13 CV0.000.14	Beak shares: Right
	1735	U 13 CV0.000.15	Beak shares: Left
	1736	U 1300 P90.030.1	Beak shares: Right
	1737	U 1300 P90.031.1	Beak shares: Left
	1738	U 1300 A P90.04001	Beak shares: Right
	1739	U 1300 A P90.04001	Beak shares: Left
	1740	U 15	Beak shares: Right
	1741	U 15	Beak shares: Left
	1742	U 1500 P91.030.01	Beak shares: Right
	1743	U 1500 P91.031.01	Beak shares: Left
	1744	U 1300 M P90.034.03	Shares for rev. points: Right
	1745	U 1300 M P90.035.03	Shares for rev. points: Left
	1746	U 1500 M P91.034.03	Shares for rev. points: Right
	1747	U 1500 M P91.035.03	Shares for rev. points: Left
	1748	U13 / U15 P90.034.02	Reversible points: Right
	1749	U13 / U15 P90.035.02	Reversible points: Left

NOTE:

- All parts are made of B27 steel. It is possible to use other materials according to specific request.
- All parts are heat treated.
- Painting with water based eco-friendly colors, or powder coated upon request.
- Possibility of welded hardened/self-sharpening blades upon request.

Image	No.	Original no.	Name
	1750	UN 300 M PK2.011.01	Shares for rev. points: Right
	1751	UN 300 M PK2.012.01	Shares for rev. points: Left
	1752	UNM 35 PK3.013.01	Shares for rev. points: Right
	1753	UNM 35 PK3.014.01	Shares for rev. points: Left
	1754	PK 8R PK8.011.01	Reversible points: Right
	1755	PK 8L PK8.011.02	Reversible points: Left
	1756	UNM 40 PK4.013.01	Shares for rev. points: Right
	1757	UNM 40 PK4.014.01	Shares for rev. points: Left
	1758	UNM 43 PK5.013.01	Shares for rev. points: Right
	1759	UNM 43 PK5.014.01	Shares for rev. points: Left
	1760	WSM 35 PK6.013.01	Shares for rev. points: Right
	1761	WSM 35 PK6.014.01	Shares for rev. points: Left
	1762	WSM 40 PK7.013.01	Shares for rev. points: Right
	1763	WSM 40 PK7.014.01	Shares for rev. points: Left
	1764	WSM 43 PK8.013.01	Shares for rev. points: Right
	1765	WSM 43 PK8.014.01	Shares for rev. points: Left
	1766	WY 3500 M P93.030.05	Shares for rev. points: Right
	1767	WY 3500 M P93.031.05	Shares for rev. points: Left
	1768	WY 4000 M P93.030.06	Shares for rev. points: Right
	1769	WY 4000 M P93.031.06	Shares for rev. points: Left

NOTE:

- All parts are made of B27 steel. It is possible to use other materials according to specific request.
- All parts are heat treated.
- Painting with water based eco-friendly colors, or powder coated upon request.
- Possibility of welded hardened/self-sharpening blades upon request.

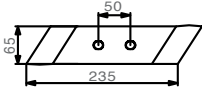
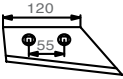
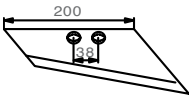
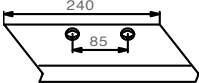
Image	No.	Original no.	Name	
	1770	PK 8R PK8.011.01	Reversible points: Right	
	1771	PK 8L PK8.011.02	Reversible points: Left	
	1772	WS 350 LK2.000.03	Shares: Right	
	1773	WS 350 LK2.000.04	Shares: Left	
	1774	WS 400 LK2.000.05	Shares: Right	
	1775	WS 400 LK2.000.06	Shares: Left	
	1776	WS 430 LK2.000.07	Shares: Right	
	1777	WS 430 LK2.000.08	Shares: Left	
	1778	WSM 35 LK2.001.03	Shares: Right	
	1779	WSM 35 LK2.001.04	Shares: Left	
	1780	WSM 40 LK2.001.05	Shares: Right	
	1781	WSM 40 LK2.001.06	Shares: Left	
	1782	WSM 43 LK2.001.07	Shares: Right	
	1783	WSM 43 LK2.001.08	Shares: Left	
	  	1784	P65.20.02	Skim points: Right
		1785	P66.70.01 260.00.19	Skim points: Right
		1786	P66.70.04 260.00.20	Skim points: Left
		1787	PE3.231.01 LZ 135 601	Skim points: Right
1788		PE3.232.01 LZ 135 701	Skim points: Left	

NOTE:

- All parts are made of B27 steel. It is possible to use other materials according to specific request.
- All parts are heat treated.
- Painting with water based eco-friendly colors, or powder coated upon request.
- Possibility of welded hardened/self-sharpening blades upon request.

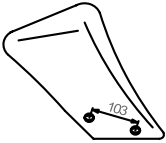
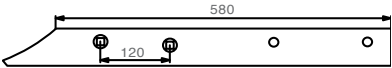
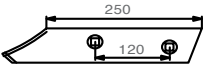
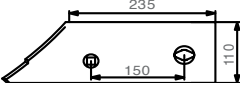
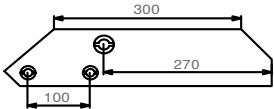
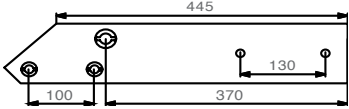
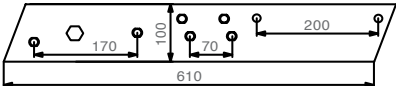
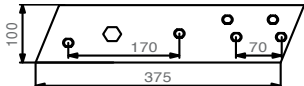
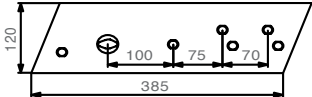
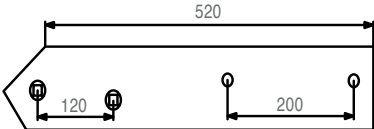
Image	No.	Original no.	Name
	1789	PA 3.054.02	Skimmer mouldboards: Right
	1790	PA 3.055.02	Skimmer mouldboards: Left
	1791	WS 275 P51.003.01	Long landsides: Right
	1792	WS 275 P51.004.01	Long landsides: Left
	1793	WS 275 P51.001.03	Up-front short landsides: Right
	1794	WS 275 P51.002.03	Up-front short landsides: Left
	1795	10M2 P10.003.03	Up-front short landsides
	1796	274 P82.074.01	Up-front landsides: Right
	1797	274 P82.075.01	Up-front landsides: Left
	1798	274 P82.077.00	Back landsides: Right
	1799	274 P82.076.00	Back landsides: Left
	1800	P89.036.01	Long landsides: Right
	1801	P89.037.01	Long landsides: Left
	1802	P89.034.01	Short front landsides: Right
	1803	P89.035.01	Short front landsides: Left
	1804	PK8.034.01	Landsides: Right
	1805	PK8.035.01	Landsides: Left
	1806	P50.001.05	Landside tips: Right
	1807	P50.002.05	Landside tips: Left

NOTE:

- All parts are made of B27 steel. It is possible to use other materials according to specific request.
- All parts are heat treated.
- Painting with water based eco-friendly colors, or powder coated upon request.
- Possibility of welded hardened/self-sharpening blades upon request.

Image	No.	Original no.	Name
	1808	P50.003.01	Landside tips: Right
	1809	P50.004.01	Landside tips: Left
	1810	PR7.030.03	Landsides: Right / Left
	1811	PR7.030.02	Landsides: Right / Left
	1812	PR7.030.01	Wear platte: Right / Left
	1813	P50.001.07	Landside protections: Right / Left
	1814	P50.001.07 A	Landside protections
	1815	P51.003.02	Landside protections: Right / Left
	1816	P58.009.01	Long landside protections: Right / Left
	1817	P58.011.01	Short landside protections: Right / Left
	1818	286 P82.076.02	Landside protections

NOTE:

- All parts are made of B27 steel. It is possible to use other materials according to specific request.
- All parts are heat treated.
- Painting with water based eco-friendly colors, or powder coated upon request.
- Possibility of welded hardened/self-sharpening blades upon request.

Image	No.	Original no.	Name
	1819	WS 275 P51.015.03	Shin pieces: Right
	1820	WS 275 P51.016.03	Shin pieces: Left
	1821	W 275 P50.001.02	Shin pieces: Right
	1822	W 275 P50.002.02	Shin pieces: Left
	1823	W 300 P52.001.03	Shin pieces: Right
	1824	W 300 P52.002.03	Shin pieces: Left
	1825	WSU 300 P58.001.03	Shin pieces: Right
	1826	WSU 300 P58.002.03	Shin pieces: Left
	1827	M 300 P54.001.02	Shin pieces: Right
	1828	MS 300 P60.001.03	Shin pieces: Right
	1829	M 350 PK9.001.02 (P55.011.05)	Shin pieces: Right
	1830	M 350 PK9.002.02	Shin pieces: Left
	1831	WS / WY 350 PK6.005.00	Shin pieces: Right
	1832	WS / WY 350 PK6.006.00	Shin pieces: Left
	1833	UN 350 PK3.001.02	Rear mouldboards: Right
	1834	UN 350 PK3.002.02	Rear mouldboards: Left
	1835	UN 350 PK3.001.03	Shin pieces: Right
	1836	UN 350 PK3.002.03	Shin pieces: Left

NOTE:

- All parts are made of B27 steel. It is possible to use other materials according to specific request.
- All parts are heat treated.
- Painting with water based eco-friendly colors, or powder coated upon request.
- Possibility of welded hardened/self-sharpening blades upon request.

Image	No.	Original no.	Name
	1837	UN 400 PK4.001.02	Rear mouldboards: Right
	1838	UN 400 PK4.002.02	Rear mouldboards: Left
	1839	UN 400 PK4.001.03	Shin pieces: Right
	1840	UN 400 PK4.002.03	Shin pieces: Left
	1841	UN 430 PK5.001.03	Shin pieces: Right
	1842	UN 430 PK5.002.03	Shin pieces: Left
	1843	WS 400 PK0.001.02	Shin pieces: Right
	1844	WS 400 PK0.002.02	Shin pieces: Left
	1845	WY 400 A PK8.005.01	Shin pieces: Right
	1846	WY 400 A L PK8.006.01	Shin pieces: Left
	1847	PK2.001.03	Shin pieces: Right
	1848	PK2.002.03	Shin pieces: Left
	1849	UST 400 PRO.001.01	Slats I: Right
	1850	UST 400 PRO.001.02	Slats II: Right
	1851	UST 400 PRO.001.03	Slats III: Right
	1852	UST 400 PRO.001.04	Slats IV: Right
	1853	UST 400 PRO.002.01	Slats I: Left
	1854	UST 400 PRO.002.02	Slats II: Left
1855	UST 400 PRO.002.03	Slats III: Left	
1856	UST 400 PRO.002.04	Slats IV: Left	
1857	UN 400 PK4.001.03	Shin pieces: Right	
1858	UN 400 PK4.002.02	Shin pieces: Left	

NOTE:

- All parts are made of B27 steel. It is possible to use other materials according to specific request.
- All parts are heat treated.
- Painting with water based eco-friendly colors, or powder coated upon request.
- Possibility of welded hardened/self-sharpening blades upon request.

Image	No.	Original no.	Name
	1859	UL 430 PR3.001.01	Slats I: Right
	1860	UL 430 PR3.001.02	Slats II: Right
	1861	UL 430 PR3.001.03	Slats III: Right
	1862	UL 430 PR3.001.04	Slats IV: Right
	1863	UL 430 PR3.002.01	Slats I: Left
	1864	UL 430 PR3.002.02	Slats II: Left
	1865	UL 430 PR3.002.03	Slats III: Left
	1866	UL 430 PR3.002.04	Slats IV: Left
	1867	UN 400 PK4.001.03	Shin pieces: Right
	1868	UN 400 PK4.002.03	Shin pieces: Left
	1869	WY 400 PK8.051.02	Trashboards: Right
	1870	WY 400 PK8.052.02	Trashboards: Left
	1871	PK2.015.01	Share knife: Right
	1872	PK2.016.01	Share knife: Left
	1873	CV.00.4508	Small ploughshare
	1874	U36 10002	Reversible point
	1875	U86 10004	Chopper knife
	1876	PE4.000.16-CKV25	Plough axle
	1877	PF3.000.16-CKV25	Plough axle

NOTE:

- All parts are made of B27 steel. It is possible to use other materials according to specific request.
- All parts are heat treated.
- Painting with water based eco-friendly colors, or powder coated upon request.
- Possibility of welded hardened/self-sharpening blades upon request.

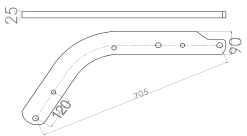
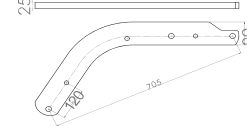
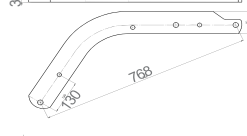
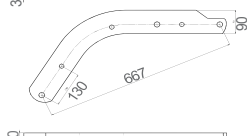
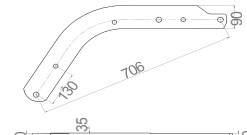
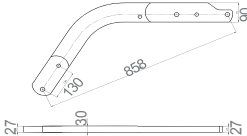
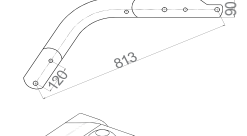
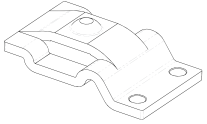
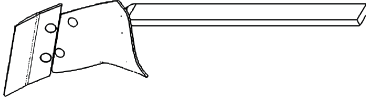
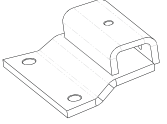
Image	No.	Original no.	Name
	1878	PP000.18-CKV25	Plough axle
	1879	PP.00020-CKV30_27	Plough axle
	1880	PG.00016-CKV30	Plough axle
	1881	PG.00018-CKV30	Plough axle
	1882	PG.0022-CKV30	Plough axle
	1883	PG.00028-CKV35_30	Plough axle
	1884	PP.00022-CKV30_27	Plough axle
	1885	LV034101	Peeler holder
	1886	LZ 334 200	Peeler
	1887	LZ 134 100	Peeler holder

NOTE:

- All parts are made of B27 steel. It is possible to use other materials according to specific request.
- All parts are heat treated.
- Painting with water based eco-friendly colors, or powder coated upon request.
- Possibility of welded hardened/self-sharpening blades upon request.

